

DIMENSIONS TABLE

UNIT : mm

NOMINAL SIZE		ANSI Class 150						L	t		H	H1	S	S1	S2	S3	S4	S5	S6	S7	S8	P			
		d	D	C	n	h	D1		D2	GRINNEL STANDARD													AV STANDARD	PVC C-PVC	PP PVDF
65mm	2½"	67	178	139.5	4	19	171	280	34	—	250	22	23	423	61	85	M8	15	—	—	—	—	—	¼	
80	3	78	191	152.5	4	19	195	305	42	263.5	280	22	23	455	109	—	—	—	12	180	220	175	215	19	¼
100	4	100	229	190.5	8	19	235	385	50	328.5	340	22	24	582	119	—	—	—	15	230	270	220	260	19	¼

NOTE.

1. Operation of permission pressure: 0.4~0.6MPa G
2. Diaphragms except EPDM and PTFE are available in FKM, VIFLON® C (FKM-C), VIFLON® F (FKM-F), CSM and NBR when required.
3. The shape and appearance of assembly differ a little with nominal size compared to this drawing.

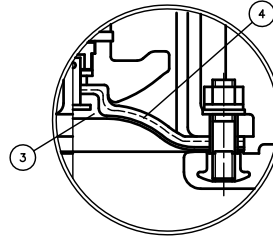

In case material of diaphragm is PTFE.

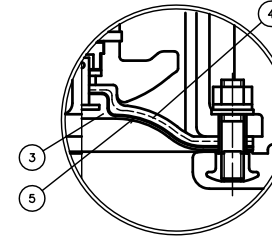

In case material of diaphragm is PTFE with cushion cover.

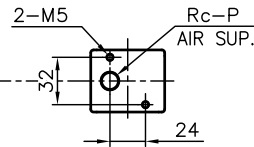
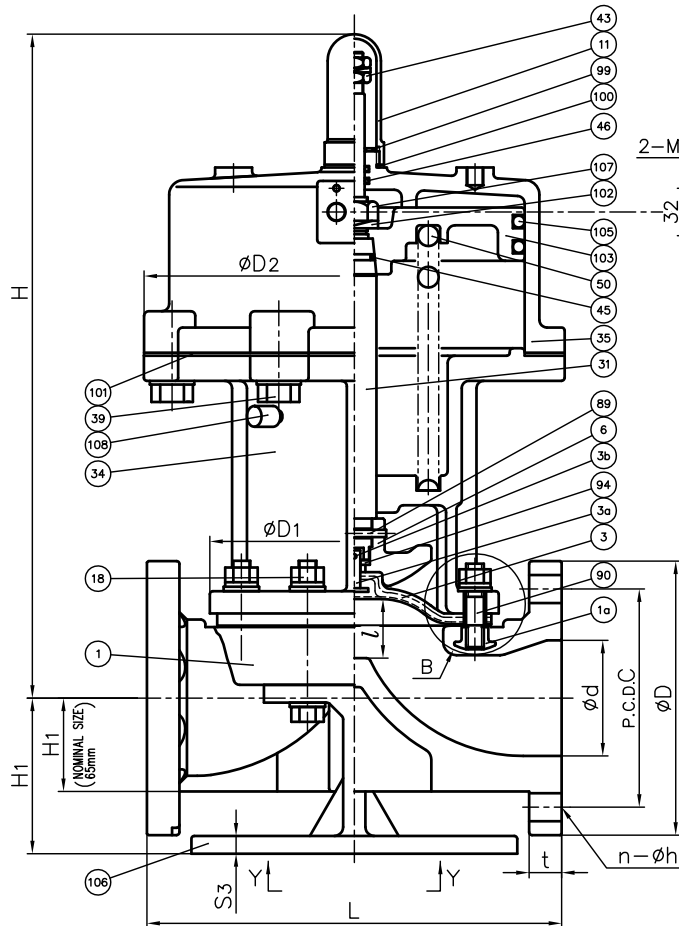

In Case of PVDF Body

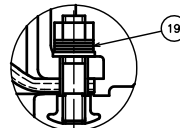

"B" Part

Y-Y
(80,100mm)

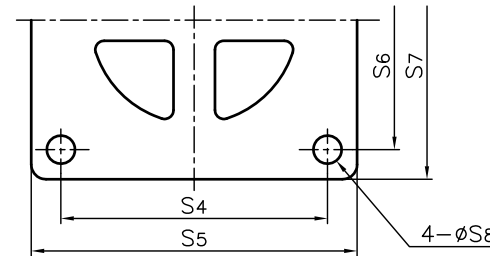

(65mm) 2-S1 Depth S2

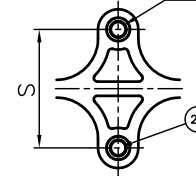

No.	DESCRIPTION	QTY.	MATERIAL	REMARKS
108	CHECK VALVE FOR EXHAUST	1	COPPER ALLOY (C3604)	
107	LOCK NUT	2	Chromized STEEL (SS400)	
106	STAND	1	CAST ALUMINUM ALLOY (AC4C) (Epoxy Coat)	Used for Size 80,100mm
105	O-RING (H)	2	NBR	
103	PISTON	1	CAST ALUMINUM ALLOY (AC5A)	
102	SPRING WASHER (A)	1	SPRING STEEL (SUP)	
101	SHEET GASKET (B)	1	NBR	
100	SHEET GASKET (A)	1	EPDM	
99	VALVE SHEET	1	STAINLESS STEEL (SUS304)	
94	METAL OF COMPRESSOR	1	STAINLESS STEEL (SUS304)	
90	STUD BOLT · NUT	4Sets	STAINLESS STEEL (SUS304)	
89	COMPRESSOR PIN	1	STAINLESS STEEL (SUS304)	
50	SPRING (C)	1	SPRING STEEL (SUP)	
46	O-RING (F)	2	NBR	
45	O-RING (E)	1	NBR	
43	STOPPER (B)	1	STAINLESS STEEL (SUS304)	
39	BOLT (A)	—	STAINLESS STEEL (SUS304)	
35	CYLINDER BONNET	1	CAST ALUMINUM ALLOY (AC4C)	Epoxy Coat
34	CYLINDER BODY	1	CAST ALUMINUM ALLOY (AC4C)	Epoxy Coat
31	STEM (A)	1	STAINLESS STEEL (SUS304)	
24	ENSAT FOR BODY	2	COPPER ALLOY (Equal to C3604)	Used for Size 65mm
19	CONICAL SPRING WASHER (A)	8Sets	STAINLESS STEEL (SUS304)	Used for PVDF Body
18	BOLT · NUT (A)	4Sets	STAINLESS STEEL (SUS304)	
11	GAUGE COVER	1	PC	
6	COMPRESSOR	1	PVDF	
5	CUSHION COVER	1	<input type="checkbox"/> Nothing <input type="checkbox"/> PVDF	Used for PTFE Diaphragm
4	CUSHION	1	EPDM	
3b	DIAPHRAGM PIN	1	STAINLESS STEEL (SUS304)	
3a	INSERTED METAL OF DIAPHRAGM	1	STAINLESS STEEL (SUS304)	
3	DIAPHRAGM	1	<input type="checkbox"/> EPDM <input type="checkbox"/> PTFE <input type="checkbox"/> Others ()	
1a	INSERTED NUT	4	COPPER ALLOY (C3604) STAINLESS STEEL (SUS304)	Used for PVC,C-PVC,PP Body Used for PVDF Body
1	BODY	1	<input type="checkbox"/> PVC <input type="checkbox"/> C-PVC <input type="checkbox"/> PP <input type="checkbox"/> PVDF	

ITEM	DIAPHRAGM VALVE (TYPE 14) PNEUMATIC ACTUATED MODEL TYPE AV ASS'Y AIR TO SHUT ANSI Class 150 : FLANGED END 65mm (2½") ~ 100mm (4")		
DRAWN	M.Iwakiri	DATE	SCALE
CHECKED	H.Kawano	FEB.7.2019	~
APPROVED	K.Koushou	DRAWING No. D1-AA019AEm	
SPECIAL ORDER No.	ASAHI YUKIZAI CORPORATION		