

DIMENSIONS TABLE

Unit: mm

Nominal Size	FLANGE END										SOCKET END					THREADED END				SPIGOT END								ACTUATOR TYPE													
	DIN PN10					PVC, C-PVC					PP, PVDF									PVC				PP, PVDF																	
	d	d'	D	C	n	h	L	t	H ₁	d ₁	ℓ	L	H ₁	d ₁	d ₁ '	ℓ	L	H ₁	d ₂	ℓ	L	H ₁	d ₃	d ₃ '	ℓ	L	H ₁	d ₃	ℓ	PP	PVDF	L	H ₁	D ₁	H	A	A ₂	A ₃	P	ACTUATOR TYPE	
15mm	1/2"	15	15	95	65	4	14	130	12	88	20	16	102	72	19.5	19.3	14.5	99	71	Rp 1/2	15	102	74	20	15	18.5	124	83	20	18.5	2.5	1.9	124	83	48	131	154	28	38	1/8	AR040NC20CN
20	3/4"	20	20	105	75	4	14	150	14	104	25	19	120	85	24.5	24.3	16	114	83	Rp 3/4	17	120	89	25	20	24	144	99	25	22	2.7	1.9	144	99	60	137.5	154	28	38	1/8	AR040NC20CN
25	1"	25	25	115	85	4	14	160	14	120	32	22	131	104	31.5	31.3	18	123	100	Rp 1	20	131	105	32	25	24.5	154	115	32	22.5	3.0	2.4	154	115	70	169	194	35	49	1/4	AR050NC30CN
32	1 1/4"	40	32	140	100	4	18	212	16	165	40	26	173	147	39.45	39.2	20.5	148	131	Rp 1 1/4	22	163	141	-	-	-	-	-	-	-	-	-	-	100	208.5	254	42.5	57	1/4	AR063NC40CN	
40	1 1/2"	40	32	150	110	4	18	200	16	159	50	31	163	142	49.45	49.2	23.5	148	131	Rp 1 1/2	25	163	141	50	40	34	194	153	50	32	4.6	3.0	194	153	100	208.5	254	42.5	57	1/4	AR063NC40CN
50	2"	51	43	165	125	4	18	230	16	185	63	38	197	170	62.5	62.1	27.5	176	154	Rp 2	28	197	168	63	51	38	224	178	63	36	5.8	3.0	224	178	126	220	254	42.5	57	1/4	AR063NC40CN

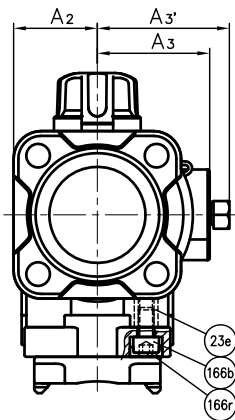

Actuator Shape (AR040)

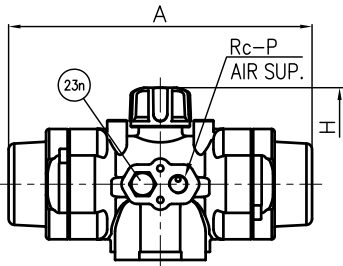

FLANGE END

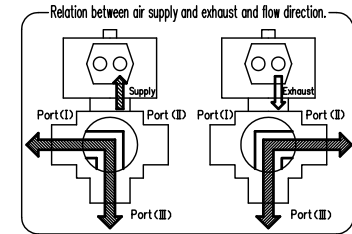
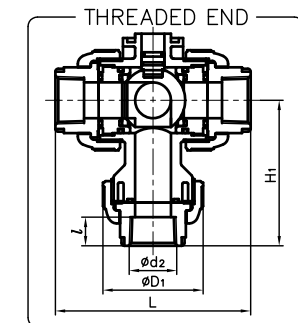
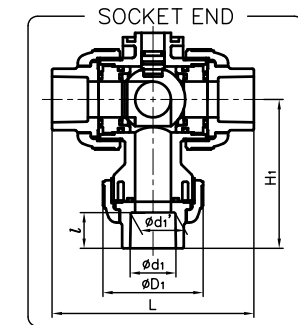
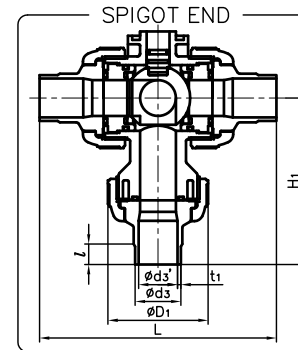
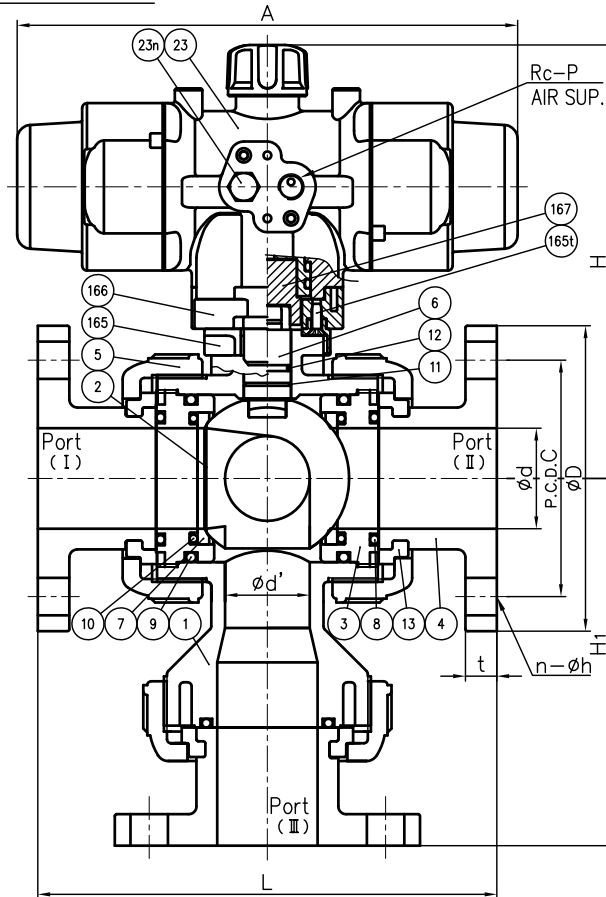

No.	DESCRIPTION	QTY.	MATERIAL	REMARKS
4a	RING	3	STAINLESS STEEL (SUS304)	Used for C-PVC Body, Threaded End: 1/2"~1"
167	SHAFT ADAPTER	1	COPPER ALLOY (C3604)	
166r	CAP (No.166)	4	EPDM	
166b	BOLT (No.166)	4	STAINLESS STEEL (SUS304)	
166	CONNECTOR PLATE	1	PPG	
165t	TAPPING SCREW (No.165)	2	STAINLESS STEEL (SUS304)	
165	BASE PLATE	1	PPG	
23n	NIPPLE (No.23)	1	PPG	
23e	ENSAT (No.23)	4	COPPER ALLOY (C3604)	
23	ACTUATOR	1	PPG etc.	
13	STOP RING	3	PVDF	Used for Flanged End
12	O-RING (E)	1		
11	O-RING (D)	1	□EPDM	
10	O-RING (C)	2	□FKM	
9	O-RING (B)	2	□Others	()
8	O-RING (A)	3		
7	SEAT	2	PTFE	
6	STEM	1		
5	UNION NUT	3	□PVC	
4	END CONNECTOR	3	□C-PVC	
3	CARRIER	2	□PP	
2	BALL	1	□PVDF	
1	BODY	1		

ITEM	3-WAY BALL VALVE (TYPE 23) PNEUMATIC MODEL AIR TYPE ASSY AIR TO SHUT: DOUBLE L-PORT TYPE DIN: □FLANGED END, □SOCKET END, □THREADED END, □SPIGOT END 15mm (1/2") ~50mm (2")		
DRAWN	M.Iwakiri	DATE	SCALE
CHECKED	H.Kawano	JUL.31.2018	~
APPROVED	K.Koushou	DRAWING No.	
SPECIAL ORDER No.	T3-AA057DE		
ASAHI YUKIZAI CORPORATION			

NOTE.

- Operating Pressure: 0.4~0.7MPa G
- Port I ♦ III: Supply
Port II ♦ III: Exhaust
- The shape and appearance of assembly differ a little with nominal size compared to this drawing.