

Serial No.	H-V019-E-7
------------	------------

Constant Flow Valves

User's Manual





Contents

(1) Be sure to read the following warranty clauses of our product	1
(2) General operating instructions	2
(3) General instructions for transportation unpacking and storage	3
(4) Names of parts	4
(5) Specifications	6
(6) Principle & operation	7
(7) Installation procedure	8
(8) Operating procedure	10
(9) Inspection items	10
(10) Troubleshooting	11
(11) Disassembly procedure for cleaning the inside of valve	11
(12) Handling of residual and waste materials	14



ASAHI YUKIZAI CORPORATION

This User's Guide contains information important to the proper installation, maintenance and safe use of the ASAHI AV product store in an easily accessible location.

<Warning & Caution Signs>

 Warning	<p>This symbol reminds the user to take caution due to the potential for serious injury or death.</p>
 Caution	<p>This symbol reminds the user to take caution due to the potential for damage to the valve if used in such a manner.</p>

<Prohibited & Mandatory Action Signs>

	<p>Prohibited: When operating the valve, this symbol indicates an action that should not be taken.</p>
	<p>Mandatory action: When operating the valve, this symbol indicates mandatory actions that must be adhered to.</p>

(1) Be sure to read the following warranty clauses of our product

- Always observe the specifications of and the precautions and instructions on using our product.
- We always strive to improve product quality and reliability, but cannot guarantee perfection. Therefore, should you intend to use this product with any equipment or machinery that may pose the risk of serious or even fatal injury, or property damage, ensure an appropriate safety design or take other measures with sufficient consideration given to possible problems. We shall assume no responsibility for any inconvenience stemming from any action on your part without our written consent in the form of specifications or other documented approval.
- The related technical documents, operation manuals, and other documentation prescribe precautions on selecting, constructing, installing, operating, maintaining, and servicing our products. For details, consult with our nearest distributor or agent.
- Our product warranty extends for one and a half years after the product is shipped from our factory or one year after the product is installed, whichever comes first. Any product abnormality that occurs during the warranty period or which is reported to us will be investigated immediately to identify its cause. Should our product be deemed defective, we shall assume the responsibility to repair or replace it free of charge.
- Any repair or replacement needed after the warranty period ends shall be charged to the customer.
- The warranty does not cover the following cases:
 - (1) Using our product under any condition not covered by our defined scope of warranty.
 - (2) Failure to observe our defined precautions or instructions regarding the construction, installation, handling, maintenance, or servicing of our product.
 - (3) Any inconvenience caused by any product other than ours.
 - (4) Remodeling or otherwise modifying our product by anyone other than us.
 - (5) Using any part of our product for anything other than the intended use of the product.
 - (6) Any abnormality that occurs due to a natural disaster, accident, or other incident not stemming from something inside our product.

(2) General Operating Instructions



Warning

- Using a positive-pressure gas with our plastic piping may pose a dangerous condition due to the repellent force particular to compressible fluids even when the gas is under similar pressures used for liquids. Therefore, be sure to take the necessary safety precautions such as covering the piping with protective material. For inquiries, please contact us. For conducting a leak test on newly installed piping, be sure to check for leaks under water pressure. If absolutely necessary to use a gas in testing, please consult your nearest service station beforehand.

- Since the Asahi AV constant flow valve has four types of A-D according to piping and fluid conditions, make sure of the product specifications after removing the valve from the packing case.



Caution

- Do not step on or apply excessive weight on valve. (It can be damaged.)

- Do not use the valve for the fluid having a viscosity of more than 35cp.

- Do not use the valve in conditions where the fluid may have crystallized. (The valve will not operate properly.)



- Keep the valve away from excessive heat or fire. (It can be damaged, or destroyed.)

- The flow rate scale of the opening indicator has already been adjusted before the products shipped so that the differences between reading and actual values meet the standard accuracy within +/- 6% of full scale.

- Always operate the valve within the pressure vs. temperature range.

(The valve can be damaged or deformed by operating beyond the allowable range.)

- Allow sufficient space for maintenance and inspection.

- Select a valve material that is compatible with the media. For chemical resistance information, refer to "CHEMICAL RESISTANCE ON ASAHI AV VALVE". (Some chemicals may damage incompatible valve materials.)

- Keep the valve out of direct sunlight, water and dust. Use cover to shield the valve. (The valve will not operate properly.)

- Perform periodic maintenance. (Leakage may develop due to temperature changes or periods of prolonged storage, rest, or operation.)





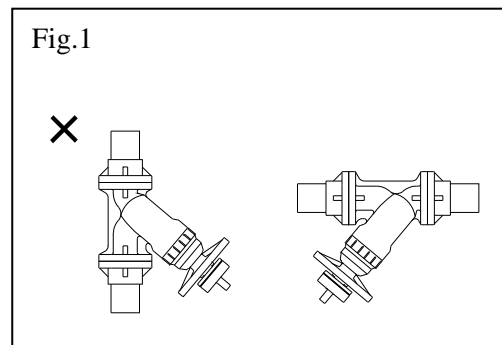

- Regardless of horizontal installation or vertical installation, the strainer with the 60-Mesh should be installed in the upper stream line of the valve in order to avoid the malfunction possibility caused by clogging of the valve by foreign matters. Do not set the configuration as shown in the drawing, because it may malfunction.

(Other than ultra pure water lines.)



- Regarding Specific Gravity, it should be less than 1.4 at the size of 15mm (1/2") to 80mm (3") and less than 1.1 at 100mm (4").

(3) General instructions for transportation, unpacking and storage

- 

 - When suspending and supporting a valve, take care and do not stand under a suspended valve.
- Warning
 

 - This valve is not designed to handle impacts of any kind.
 - Avoid throwing or dropping the valve.
 - Avoid scratching the valve with any sharp object.
 - Do not over-stack cardboard shipping boxes. Excessively stacked packages may collapse.
 - Avoid contact with any coal tar creosote, insecticides, vermicides or paint. (These chemicals may cause damage to the valve.)
- Caution
 
 - When transporting a valve, do not carry it by the handle.
- 
 - Store products in their corrugated cardboard boxes. Avoid exposing products to direct sunlight, and store them indoors (at room temperature). Also avoid storing products in areas with excessive temperatures. (Corrugated cardboard packages become weaker as they become wet with water or other liquid. Take care in storage and handling.)
- After unpacking the products, check that they are defect-free and meet the specifications.

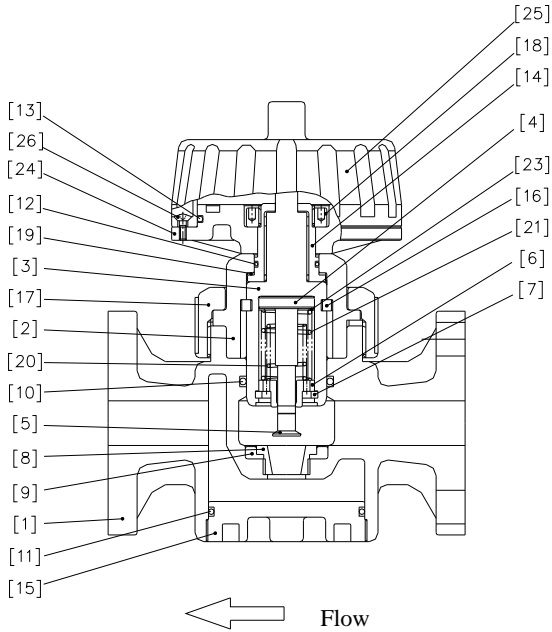
(4) Name of parts

Nominal Size: 15mm (1/2"), 20mm (3/4")



No.	DESCRIPTION	No.	DESCRIPTION
[1]	Body	[14]	Sleeve
[2]	Bonnet	[15]	Cap
[3]	Cylinder	[16]	Key
[4]	Piston	[17]	Cap nut
[5]	Plug	[18]	Nut
[6]	Spring base	[19]	Thrust ring
[7]	Stop ring	[20]	Spring (A)
[8]	Orifice	[21]	Spring (B)
[9]	Seat	[23]	Washer (B)
[10]	O-Ring (A)	[24]	Handle base
[11]	O-Ring (B)	[25]	Handle cover
[12]	O-Ring (C)	[26]	Screw
[13]	O-Ring (D)		

Nominal Size: 25mm (1")

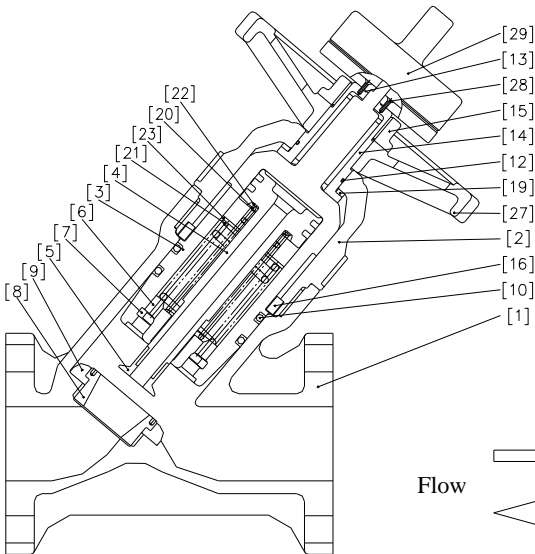

No.	DESCRIPTION	No.	DESCRIPTION
[1]	Body	[14]	Sleeve
[2]	Bonnet	[15]	Cap
[3]	Cylinder	[16]	Key
[4]	Piston	[19]	Thrust ring
[5]	Plug	[20]	Spring (A)
[6]	Spring base	[21]	Spring (B)
[7]	Stop ring	[22]	Washer (A)
[8]	Orifice	[23]	Washer (B)
[9]	Seat	[27]	Hand Wheel
[10]	O-Ring (A)	[28]	Screw
[12]	O-Ring (C)	[29]	Indicator
[13]	O-Ring (D)		

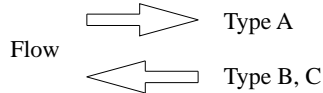

Nominal Size: 50mm (2"), 80mm (3")

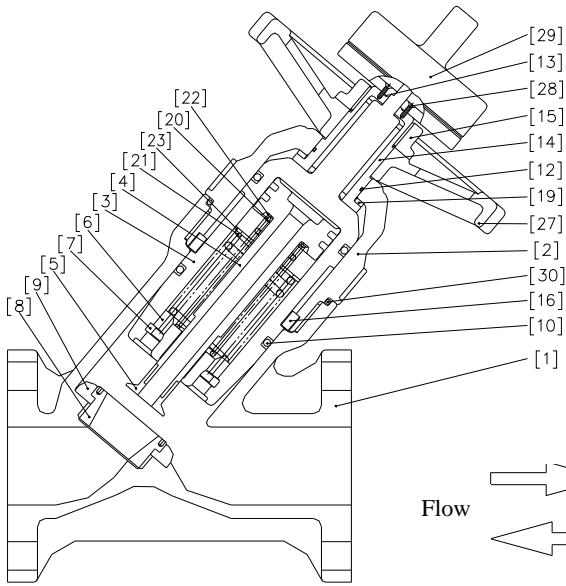

No.	DESCRIPTION	No.	DESCRIPTION
[1]	Body	[14]	Sleeve
[2]	Bonnet	[15]	Cap
[3]	Cylinder	[16]	Key
[4]	Piston	[19]	Thrust ring
[5]	Plug	[20]	Spring (A)
[6]	Spring base	[21]	Spring (B)
[7]	Stop ring	[22]	Washer (A)
[8]	Orifice	[23]	Washer (B)
[9]	Seat	[27]	Hand Wheel
[10]	O-Ring (A)	[28]	Screw
[12]	O-Ring (C)	[29]	Indicator
[13]	O-Ring (D)	[30]	O-Ring (E)

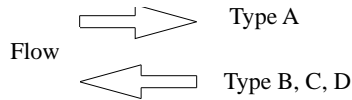

Nominal Size: 100mm (4")

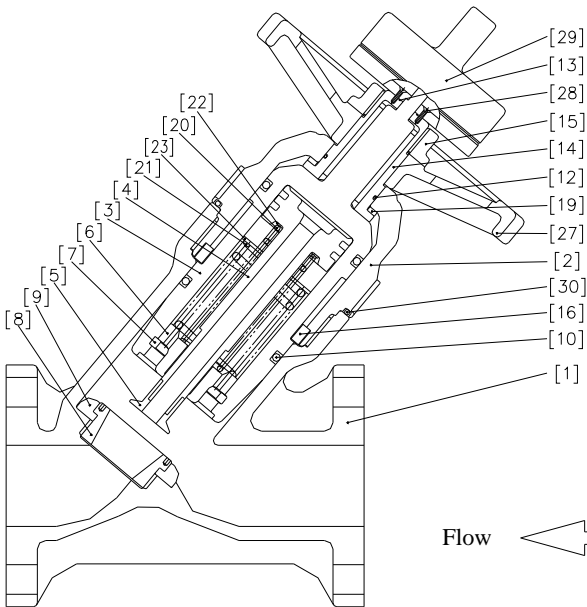

No.	DESCRIPTION	No.	DESCRIPTION
[1]	Body	[14]	Sleeve
[2]	Bonnet	[15]	Cap
[3]	Cylinder	[16]	Key
[4]	Piston	[19]	Thrust ring
[5]	Plug	[20]	Spring (A)
[6]	Spring base	[21]	Spring (B)
[7]	Stop ring	[22]	Washer (A)
[8]	Orifice	[23]	Washer (B)
[9]	Seat	[27]	Hand Wheel
[10]	O-Ring (A)	[28]	Screw
[12]	O-Ring (C)	[29]	Indicator
[13]	O-Ring (D)	[30]	O-Ring (E)

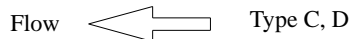

(5) Specifications

- Working Temperature : PVC = 0-50°C (30 - 120° F), C-PVC = 0-70°C (30 - 160° F)
- Upstream Working Pressure : 0.25MPa (2.6kgf / cm²) or less
 0.25 to 0.5 MPa (2.6 to 5.1kgf / cm²)
 0.5 to 0.75 MPa (5.1 to 7.7kgf / cm²)
 0.75 to 1.0 MPa (7.7 to 10.2kgf / cm²)
 * Nom. size 100mm (4") is 0.5 MPa (5.1kgf / cm²) or less only.

0.1MPa = 14.286PSI

● A Type [25mm (1") – 80mm (3")]

Fluid flows through the valve inside Suitable for semi-conductor industry. (Ultra pure water line)

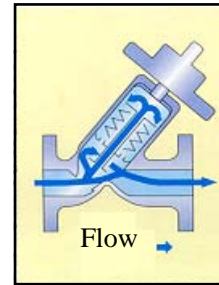

● B Type [15mm (1/2") – 80mm (3")]

Flow rate setting range is large. (Covers small flow rate to large rate)

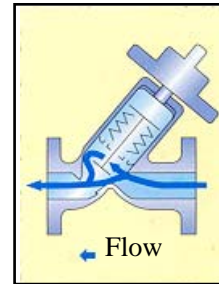

● C Type [15mm (1/2") – 100mm (4")]

Range of working differential pressure is large. (For lines with large pressure differential between upstream & downstream)

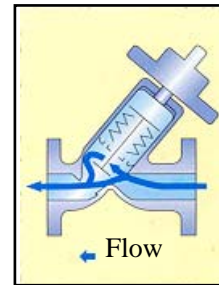

● D Type [80mm (3") – 100mm (4")]

A large flow rate can be set.

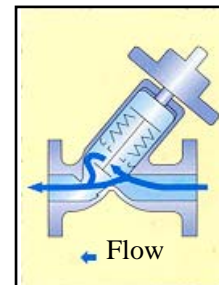

(6) Principle & Operation

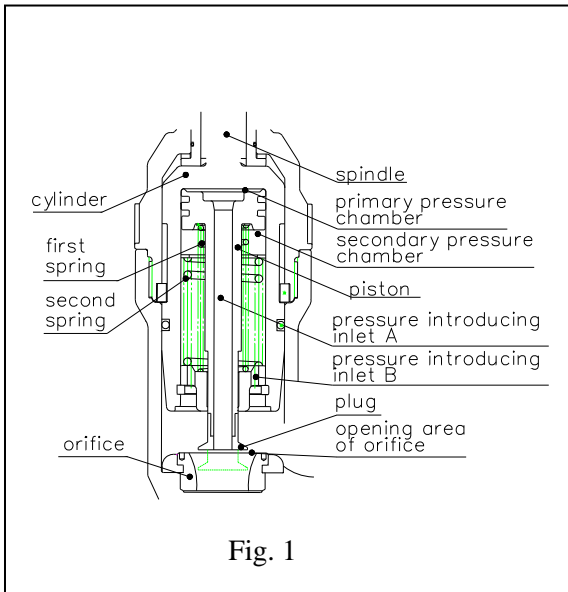

Fig. 1

Refer to Figure 1 for design and operation of ASAHI AV Flow Control Valve. When the upstream fluid pressure, P_1 is introduced at the flow control orifice, it exerts a corresponding pressure on the upper surface of the flange on the piston type valve plug.

Likewise, the downstream pressure, P_2 exerts a corresponding pressure to the lower surface of the valve plug flange. Thus, when a differential pressure exists between the fluid upstream and downstream of the orifice, the corresponding pressure differential acting on the surfaces of the flange moves the valve plug piston either downward against the force of the spring cartridge or upward by the force the spring, depending upon the direction of the force induced by the existing pressure differential.

This upward or downward movement of the valve plug piston causes the flow orifice to be widened or narrowed accordingly, thus the flow rate of the fluid passing across the orifice is automatically adjusted.

For example, if the pressure differential, $P_1 - P_2$ created between the upstream and downstream side of the orifice increases, the valve plug piston moves downward to narrow the area of the orifice opening and automatically adjusts the orifice to the preset flow rate value. (With the type of B, C and D, the plug has no inlet hole for fluid, as the pressure differential $P_1 - P_2$ exerts directly on the surface of the plug.)

The reverse is also true when the pressure differential decreases, the piston moves upward increasing the orifice opening area and allowing the fluid flow rate to increase to the preset value.

Preset flow rate range for use Design flow rate ranges:

Nom. size	TYPE	Flow rate (m ³ /hr)	Range ability	Working differential pressure
15mm (1/2")	TYPE B	0.04 - 0.8	20 : 1	0.02 - 0.1MPa (0.2 - 1.0kgf/cm ²)
	TYPE C	0.08 - 0.8	10 : 1	0.03 - 0.2 MPa (0.3 - 2.0 kgf/cm ²)
20mm (3/4")	TYPE B	0.06 - 1.2	20 : 1	0.02 - 0.1 MPa (0.2 - 1.0 kgf/cm ²)
	TYPE C	0.12 - 1.2	10 : 1	0.03 - 0.2 MPa (0.3 - 2.0 kgf/cm ²)
25mm (1")	TYPE A	0.5 - 2.0	4 : 1	0.02 - 0.1 MPa (0.2 - 1.0 kgf/cm ²)
	TYPE B	0.1 - 2.0	20 : 1	0.02 - 0.1 MPa (0.2 - 1.0 kgf/cm ²)
	TYPE C	0.2 - 2.0	10 : 1	0.03 - 0.2 MPa (0.3 - 2.0 kgf/cm ²)
50mm (2")	TYPE A	2.0 - 8.0	4 : 1	0.02 - 0.1 MPa (0.2 - 1.0 kgf/cm ²)
	TYPE B	0.4 - 8.0	20 : 1	0.02 - 0.1 MPa (0.2 - 1.0 kgf/cm ²)
	TYPE C	0.8 - 8.0	10 : 1	0.03 - 0.2 MPa (0.3 - 2.0 kgf/cm ²)
80mm (3")	TYPE A	5.0 - 20.0	4 : 1	0.02 - 0.1 MPa (0.2 - 1.0 kgf/cm ²)
	TYPE B	1.0 - 20.0	20 : 1	0.02 - 0.1 MPa (0.2 - 1.0 kgf/cm ²)
	TYPE C	2.0 - 20.0	10 : 1	0.03 - 0.2 MPa (0.3 - 2.0 kgf/cm ²)
	TYPE D	15.0 - 30.0	2 : 1	0.03 - 0.15 MPa (0.3 - 1.5 kgf/cm ²)
100mm (4")	TYPE C	10.0 - 60.0	6 : 1	0.03 - 0.2 MPa (0.3 - 2.0 kgf/cm ²)
	TYPE D	30.0 - 60.0	2 : 1	0.02 - 0.2 MPa (0.2 - 2.0 kgf/cm ²)

1m³/hr = 4.4033gal/min, 0.1MPa = 14.286PSI

(7) Installation procedure



Warning

- When suspending and supporting a valve, take care and do not stand under a suspended valve.
- Be sure to conduct a safety check on all hand and power tools to be used before beginning work.
- Wear protective gloves and safety goggles as fluid remain in the valve even if the pipeline is empty. (You may be injured.)



Caution

- When installing pipes and valves, ensure that they are not subjected to tension, compression, bending, impact, or other excessive stress.
- Use flat faced flanges for connection to AV Valves.
- Ensure that the mating flanges are of the same standards.
- Every type of valve has its one flow direction across the valve. Make sure, therefore, that the flow direction is consistent with the arrow-mark indicated on the valve body when installed.
- Be sure to use sealing gaskets (AV Gasket), bolts, nuts, and washers and tighten them to specified torques.
(When a non-AV gasket is used, a different tightening specification should be followed.)

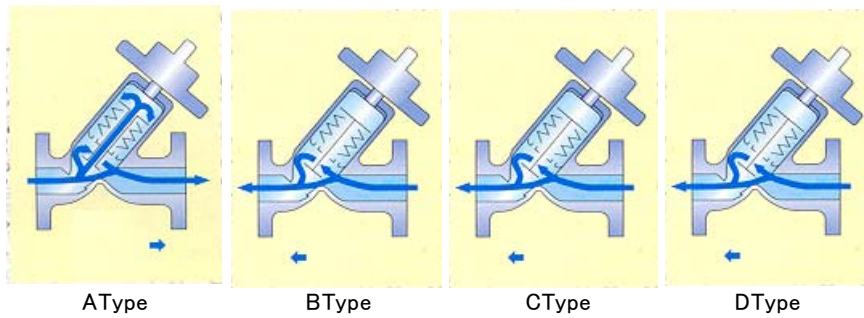

Necessary items

- Spanner wrench
- Bolt, Nut, Washer (Vary per flange type)
- Torque wrench
- AV Gasket

Procedure

- 1) Set the AV Gasket between the flanges.
- 2) Insert washers and bolts from the pipe side, insert washers and nuts from the valve side, then temporarily tighten them by hand.



Caution

- The parallelism and axial misalignment of the flange surface should be under the values shown in the following table to prevent damage the valve.
(A failure to observe them can cause destruction due to stress application to the pipe.)

Unit : mm (inch)

Nom. Size	Axial Misalignment	Parallelism (a-b)
15-25mm (1/2"-1")	1.0 (0.04)	0.5 (0.02)
40-80mm (1 1/2"-3")	1.0 (0.04)	0.8 (0.03)
100mm (4")	1.0 (0.04)	1.0 (0.04)

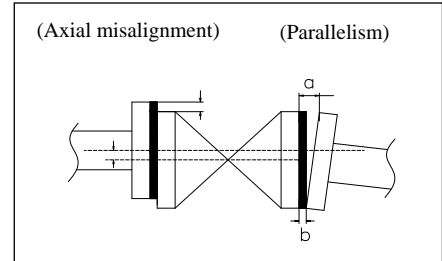

3) Using a torque wrench, tighten the bolts and nuts gradually to the specified torque in a diagonal manner (Refer to Fig.1.)



Caution

- Tighten the bolts and nuts gradually with a torque wrench to the specified torque level in a diagonal manner.

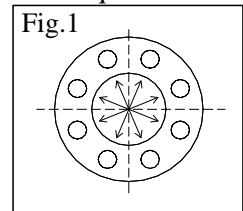



Recommended torque value

Unit: N·m {kgf·cm} [lb·inch]

Nom. Size	15-20 mm (1/2"-3/4")	25 mm (1")	50 mm (2")	80, 100 mm (3", 4")
PTFE· PVDF coated	17.5 {179} [155]	20.0 {204} [177]	22.5 {230} [230]	30.0 {306} [266]
Rubber	8.0 {82} [71]	20.0 {204} [177]	22.5 {230} [230]	30.0 {306} [266]



(8) Operating procedure

  - Do not exert excessive force in closing the valve.



Caution  - Do not use the valve to fluid containing slurry. (The valve will not operate properly.)

- The installed valve must never be opened or closed when foreign matter such as sand is present in the pipeline.
- When operating the handle, be sure to do so with your hand. (Using a tool may damage the handle.)
- Follow the procedure in setting the flow rate.



○ To operate the valve for opening / closing, turn the hand wheel slowly.
(To get the flow rate decreased, turn the hand wheel clockwise.)

  - To set new flow rate, turn the hand wheel counterclockwise to let the indicator of opening degree reach beyond the required level and then the hand wheel clockwise to obtain proper flow rate.
(This is the recommendable procedure to get exact flow rate.)

○ To shut the valve, turn the hand wheel clockwise, and adjust the indicator to the “ 0 ” position of the flow rate scale.
Application of rubber material for shut – off seat gives the valve perfect closing with little tightening torque.

  - Do not operate the valve out of scale, especially at lower level than the minimum indicated scale. (The function of valve could be deteriorated.)

(9) Inspection items

  - Perform periodic maintenance. (Leakage may develop due to temperature changes or over periods of prolonged storage, rest or operation.)

○ Inspect the following items

(1)	Existence of scratches, cracks, deformation, and discoloring.
(2)	Existence of leakage from the valve to the outside.
(3)	Existence of leakage when the valve is opened fully at right or left.

(10) Troubleshooting

Problem	Cause	Treatment
The flow rate is extraordinarily small	Insufficient Working differential pressure.	Adjust Working differential pressure.
	Foreign materials are caught.	Clean.
	Appearance of algae or seaweed on the surface of valve inside.	Clean.
	Sand is caught in the valve.	Clean.
The flow rate is larger than the range of recommended flow rate.	The plug is damaged or worn.	For further detail and assistance, consult your nearest AOC agents / branches.
	The orifice is damaged or worn.	For further detail and assistance, consult your nearest AOC agents / branches.
	It has exceeded beyond the range of Working differential pressure.	Adjust Working differential pressure.
	Appearance of algae or seaweed on the surface of valve inside.	Clean.
	Sand is caught in the valve.	Clean.
Fluid is not stopped in the full shut position.	Appearance of algae or seaweed on the surface of valve inside	Clean.
	Sand is caught in the valve.	Clean.

(11) Disassembly procedure for cleaning the inside of valve



Warning

- Do not disassemble the parts not mentioned above.
- Do not try to disassemble any part that is hard to disassemble (parts stuck together). Consult our office nearest to you.



Caution

- The flow rate scale of the opening indicator has already been adjusted before the products shipped so that the differences between reading and actual values meet the standard accuracy within +/- 6% of full scale.
- In case of removing the bonnet, the valve should be fully opened first, then remove the bonnet.
- Avoid scratching the inside parts and surface of the valve with any sharp objects.
- Do not change or replace valve parts under line pressure.

Necessary items

- Strap Wrench (*Removal of the bonnet)
- Snap Ring Plier (*Removal of the bonnet)
- Nylon Brush (*Wash The Parts)
- Grease “Silicon Grease”

Dissassembly

- 1) Open the valve fully.
- 2) Check for marking between the body and bonnet. If there is no marking, please make alignment marks with a marker as follows.
*Note ; No need for marking on 15mm (1/2") and 20mm (3/4") in nominal size.



Marking

Marking
(Using a marker)

- 3) Loosen the bonnet with a strap wrench, and remove it.



- 4) Remove the snap ring with a snap ring plier.

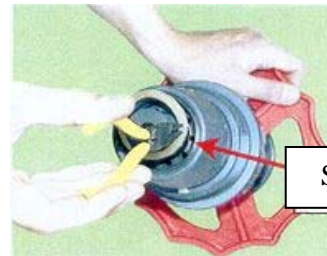

Snap ring

- 5) Remove the piston from the cylinder.



Washing

- 1) Check the valve parts for damages.
- 2) Wash the valve parts with a nylon brush.

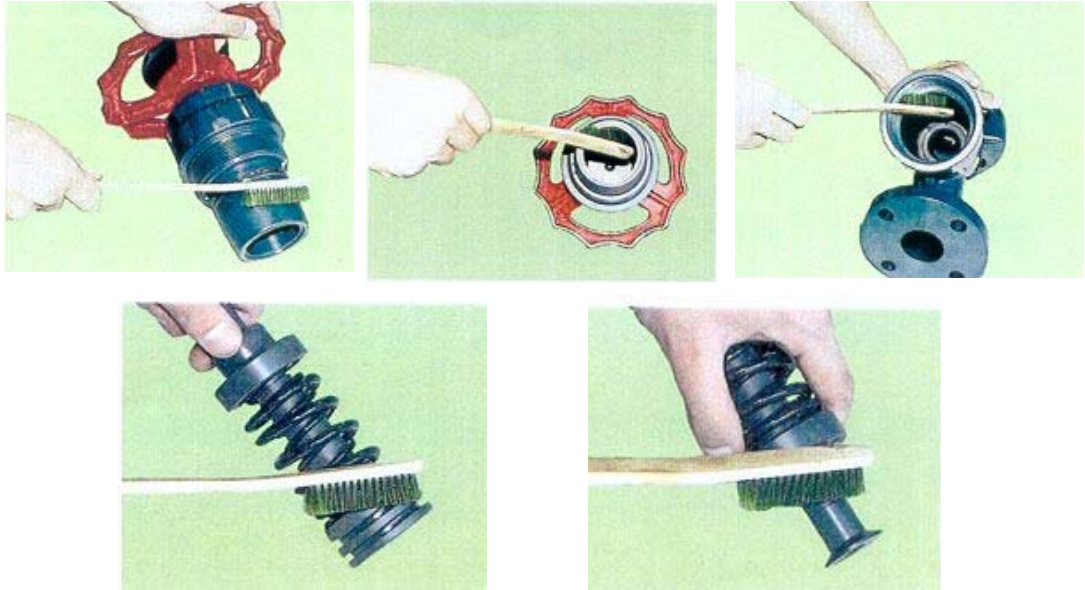

Assembly

- 1) Insert the piston into the cylinder smoothly, then insert the snap ring tightly.

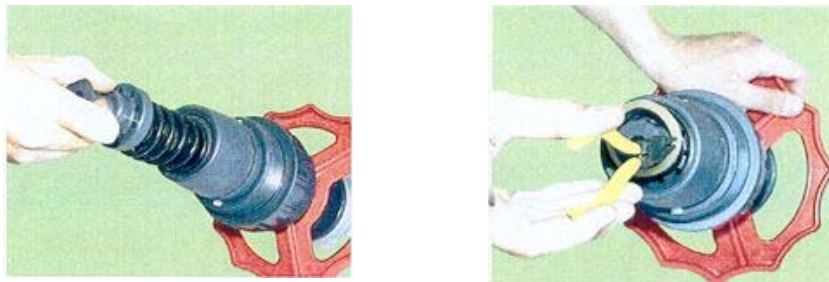

- 2) If there is no grease around the o-ring of the cylinder, apply a sufficient amount of grease to the surface of the o-ring.

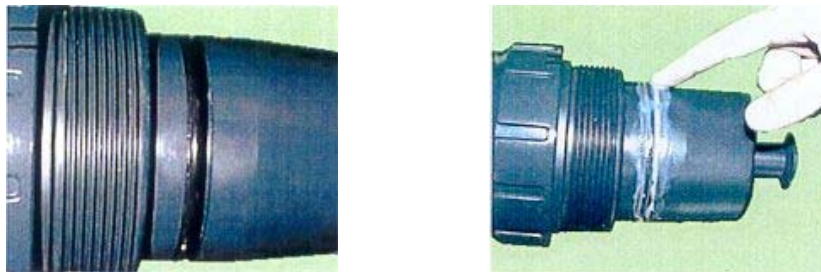

- 3) Check whether the piston moves smoothly. If not, wash the valve again.

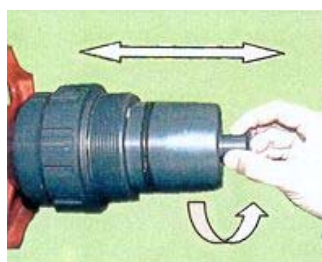

- 4) Cycle the piston assembly to 1/2 open position to keep alignment pins from falling into the bonnet cavity.
 *Note ; The valve 15mm (1/2") and 20mm (3/4") in nominal size have alignment pins.

- 5) Insert the bonnet into the body.
 *Note ; The valve 15mm (1/2") and 20mm (3/4") in nominal size have alignment pins that fit internal grooves to set normal position.



- 6) Tighten the body by hand, and using a strap wrench, tighten the bonnet until alignment marks line up.





- *Note-1 ; The valve 15mm (1/2") and 20mm (3/4") in nominal size don't have alignment marks.
- *Note-2 ; Avoid excessive tightening.(The valve can be damaged.)

Run fluid

- 1) Set the flow indicator to the preset flow rate.
- 2) Run fluid. (Operate the hand wheel slowly.)

(12) Handling of residual and waste materials

  - Make sure to consult a waste treatment dealer for recommendations on the proper disposal of plastic valves. (Poisonous gas is generated when the valve is burned improperly.)

Constant flow valve

ASAHI YUKIZAI CORPORATION

Distributor

<http://www.asahi-yukizai.co.jp/en/>

Information in this manual is subject to change without notice.

2016.4