

Serial No.	H-V035-E-13
------------	-------------

Air Release Valve (PDCPD)

Air Release Valve for Water (PDCPD + Epoxy Resin Coating)

User's manual



Air Release Valve



Air Release Valve for Water



Contents (page)

- (1) Be sure to read the following warranty clauses of our product 1
- (2) General operating instructions 2
- (3) General instructions for transportation, unpacking and storage 2
- (4) List of ancillary parts 3
- (5) Name of parts 4
- (6) Working pressure vs. temperature 7
- (7) Installation procedure 8
- (8) Operating procedure 9
- (9) Disassembling method for replacing parts 9
- (10) Inspection items 10
- (11) Troubleshooting 11
- (12) Handling of residual and waste materials 11



This user's guide contains very important information for the proper installation, maintenance and safe use of an ASAHI AV Product.

Please store this manual in an easily accessible location.

<Warning & Caution Signs>

 Warning	<p>This symbol reminds the user to take caution due to the potential for serious injury or death.</p>
 Caution	<p>This symbol reminds the user to take caution due to the potential for damage to the valve if used in such a manner.</p>

<Prohibited & Mandatory Action Signs>



	<p>Prohibited: When operating the valve, this symbol indicates an action that should not be taken.</p>
	<p>Mandatory action: When operating the valve, this symbol indicates mandatory actions that must be adhered to.</p>

1. Be sure to read the following warranty clauses of our product



- Always observe the specifications of and the precautions and instructions on using our product.
- We always strive to improve product quality and reliability, but cannot guarantee perfection. Therefore, should you intend to use this product with any equipment or machinery that may pose the risk of serious or even fatal injury, or property damage, ensure an appropriate safety design or take other measures with sufficient consideration given to possible problems. We shall assume no responsibility for any inconvenience stemming from any action on your part without our written consent in the form of specifications or other documented approval.
- The related technical documents, operation manuals, and other documentation prescribe precautions on selecting, constructing, installing, operating, maintaining, and servicing our products. For details, consult with our nearest distributor or agent.
- Our product warranty extends for one and a half years after the product is shipped from our factory or one year after the product is installed, whichever comes first. Any product abnormality that occurs during the warranty period or which is reported to us will be investigated immediately to identify its cause. Should our product be deemed defective, we shall assume the responsibility to repair or replace it free of charge.
- Any repair or replacement needed after the warranty period ends shall be charged to the customer.
- The warranty does not cover the following cases:
 - (1) Using our product under any condition not covered by our defined scope of warranty.
 - (2) Failure to observe our defined precautions or instructions regarding the construction, installation, handling, maintenance, or servicing of our product.
 - (3) Any inconvenience caused by any product other than ours.
 - (4) Remodeling or otherwise modifying our product by anyone other than us.
 - (5) Using any part of our product for anything other than the intended use of the product.
 - (6) Any abnormality that occurs due to a natural disaster, accident, or other incident not stemming from something inside our product.

* Note that damage induced by a defect of our product is not covered by warranty.

2. General operating instructions

- 
Caution
 – Do not step on or apply excessive weight on air release valve. (It can be damaged.)
- Keep the valve away from excessive heat or fire. (It can be damaged, or destroyed.)
- 
 – Always operate the valve within the pressure vs. temperature range. (The valve can be damaged or deformed by operating beyond the allowable range.)
- Allow sufficient space for maintenance and inspection.
- Do not use the valve in conditions where the fluid may have crystallized. (The valve will not operate properly.)
- Keep the valve out of direct sunlight, water and dust. Use cover to shield the valve. (The valve will not operate properly.)
- Perform periodic maintenance. (Leakage may develop due to temperature changes or over periods of prolonged storage, rest or operation.)
- If any part has the risk of freezing, insulate it thermally.
- Immediately after installing the pipeline, or in similar cases, the pipe may contain accumulated soil, sand, dirt, or dust. If, therefore, the valve is subjected to water (filled with water) for the first time, discharge such soil, sand, dirt, and dust sufficiently by using a mud discharge valve or something similar.

3. General instructions for transportation, unpacking and storage

- 
Warning
 – When suspending and supporting a valve, take care and do not stand under a suspended valve.
- 
Caution
 – This valve is not designed to handle impacts of any kind. Avoid throwing or dropping the valve.
- Avoid scratching the valve with any sharp object.
- Do not over-stack cardboard shipping boxes. Excessively stacked packages may collapse.
- Avoid contact with any coal tar creosote, insecticides, vermicides or paint. (These chemicals may cause damage to the valve.)
- 
 – Store products in their corrugated cardboard boxes. Avoid exposing products to direct sunlight, and store them indoors (at room temperature). Also avoid storing products in areas with excessive temperatures. (Corrugated cardboard packages become weaker as they become wet with water or other liquid. Take care in storage and handling.)
- After unpacking the products, check that they are defect-free and meet the specifications.

4. List of ancillary parts

Nominal size	End connectors	Ancillary parts	Remarks	Pcs.
25mm (1")	Threaded end	–	–	–
	JWWA	AV Gasket	AR*1 : SBR / JWWA 75mm (3") AR for water*1 : SBR / JWWA 75mm (3")	1
	JIS10K	AV Gasket	AR*1 : EPDM / JIS10K 80mm (3") AR for water*1 : SBR / JIS10K 80mm (3")	1
	JIS16K	Gasket with rib	AR*1 : EPDM / JIS16K 80mm (3") AR for water*1 : SBR / JIS16K 80mm (3")	1
75mm (3")	JWWA	AV Gasket	AR*1 : SBR / JWWA 75mm (3") AR for water*1 : SBR / JWWA 75mm (3")	1
		Stud bolt / Nut / Washer	M16*75L / M16 / Nom. 16	4
80mm (3")	JIS10K	AV Gasket	AR*1 : EPDM / JIS10K 80mm (3") AR for water*1 : SBR / JIS10K 80mm (3")	1
		Stud bolt / Nut / Washer	M16*75L / M16 / Nom. 16	8
	JIS16K	Gasket with rib	AR*1 : EPDM / JIS16K 80mm (3") AR for water*1 : SBR / JIS16K 80mm (3")	1
		Stud bolt / Nut*2 / Washer	M20*75L / M20 / Nom. 20	8
100mm (4")	JWWA	AV Gasket	AR*1 : SBR / JWWA 100mm (4") AR for water*1 : SBR / JWWA 100mm (4")	1
		Stud bolt / Nut / Washer	M16*75L / M16 / Nom. 16	4
	JIS10K	AV Gasket	AR*1 : EPDM / JIS10K 100mm (4") AR for water*1 : SBR / JIS10K 100mm (4")	1
		Stud bolt / Nut / Washer	M16*75L / M16 / Nom. 16	8
	JIS16K	Gasket with rib	AR*1 : EPDM / JIS16K 100mm (4") AR for water*1 : SBR / JIS16K 100mm (4")	1
		Stud bolt / Nut / Washer	M20*80L / M20 / Nom. 20	8
150mm (6")	JWWA	AV Gasket	AR*1 : SBR / JWWA 150mm (6") AR for water*1 : SBR / JWWA 150mm (6")	1
		Stud bolt / Nut / Washer	M16 × 80L / M16 / 呼び 16	6
	JIS10K	AV Gasket	AR*1 : EPDM / JIS10K 150mm (6") AR for water*1 : SBR / JIS10K 150mm (6")	1
		Stud bolt / Nut / Washer	M20*90L / M20 / Nom. 20	8
	JIS16K	Gasket with rib	AR*1 : EPDM / JIS16K 150mm (6") AR for water*1 : SBR / JIS16K 150mm (6")	1
		Stud bolt / Nut / Washer	M22*90L / M22 / Nom. 22	12
200mm (8")	JWWA	AV Gasket	AR*1 : SBR / JWWA 200mm (8") AR for water*1 : SBR / JWWA 200mm (8")	1
		Stud bolt / Nut / Washer	M16*80L / M16 / Nom. 16	8
	JIS10K	AV Gasket	AR*1 : EPDM / JIS10K 200mm (8") AR for water*1 : SBR / JIS10K 200mm (8")	1
		Stud bolt / Nut / Washer	M20*90L / M20 / Nom. 20	12
	JIS16K	Gasket with rib	AR*1 : EPDM / JIS16K 200mm (8") AR for water*1 : SBR / JIS16K 200mm (8")	1
		Stud bolt / Nut / Washer	M22*90L / M22 / Nom. 22	12

*1: "AR" means "Air Release Valve". "AR for Water" means "Air Release Valve for Water".

*2: The nut of JIS16K specification with a nominal size of 80mm is a dedicated nut for connecting with the Isolating valve JIS16K specifications.

*Bolts, nuts, and washers are not packed in nominal size 25mm (1").

5. Name of parts

● Threaded end / 25mm (1")

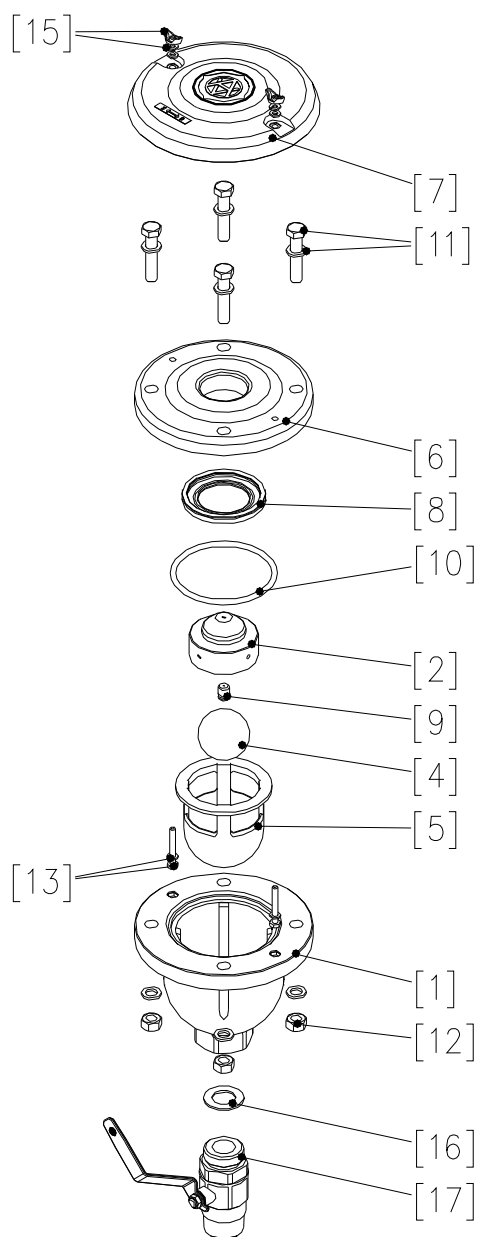

No.	Description	Remarks	No.	Description	Remarks
1	Body	AR : PDCPD AR for water : PDCPD + Epoxy resin coating	9	Seat (B)	AR : EPDM AR for water : SBR
2	Disc	PP	10	O-ring	AR : EPDM (P105) AR for water : SBR (P105)
4	Float	PP	11	Bolt, washer (A)	M12, L=60
5	Guide	HI-PVC	12	Nut (A)	M12
6	Bonnet	AR : PDCPD AR for water : PDCPD + Epoxy resin coating	13	Bolt, washer (B)	M6, L=45
7	Cover	AR : PDCPD AR for water : PDCPD + Epoxy resin coating	15	Wing nut, spring lock washer	M6
8	Seat (A)	AR : EPDM AR for water : SBR	16	Packing	AR : EPDM AR for water : SBR
			17	Isolating valve	-

● Flanged end / 25mm (1")

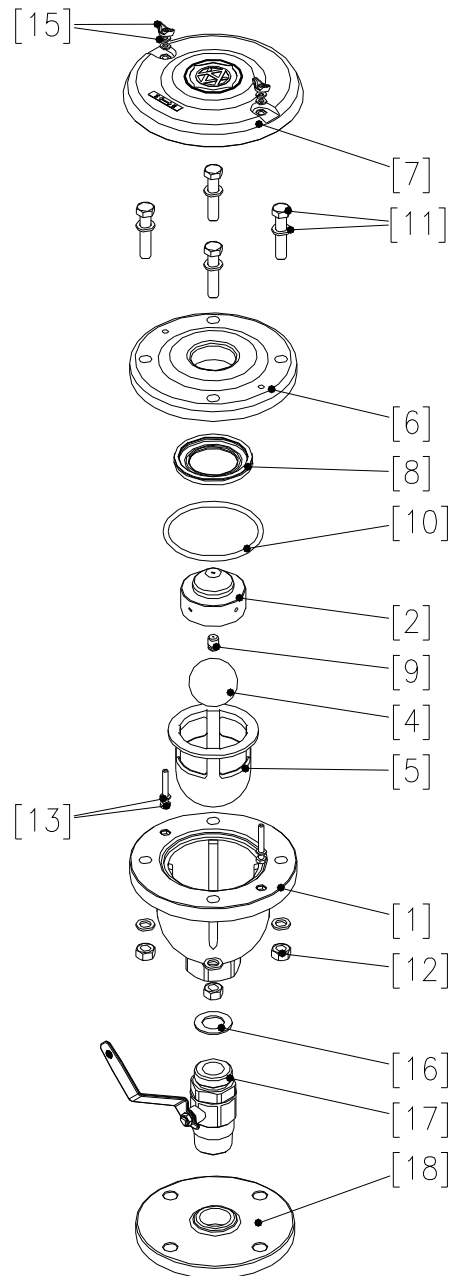

No.	Description	Remarks	No.	Description	Remarks
1	Body	AR : PDCPD AR for water : PDCPD + Epoxy resin coating	10	O-ring	AR : EPDM (P105) AR for water : SBR (P105)
2	Disc	PP	11	Bolt, washer (A)	M12, L=60
4	Float	PP	12	Nut (A)	M12
5	Guide	HI-PVC	13	Bolt, washer (B)	M6, L=45
6	Bonnet	AR : PDCPD AR for water : PDCPD + Epoxy resin coating	15	Wing nut, spring lock washer	M6
7	Cover	AR : PDCPD AR for water : PDCPD + Epoxy resin coating	16	Packing	AR : EPDM AR for water : SBR
8	Seat (A)	AR : EPDM AR for water : SBR	17	Isolating valve	-
9	Seat (B)	AR : EPDM AR for water : SBR	18	Flange	AR : FCD450 AR for water : FCD450 + Epoxy resin coating

● Flanged end / 75(80)-200mm (3"-8")

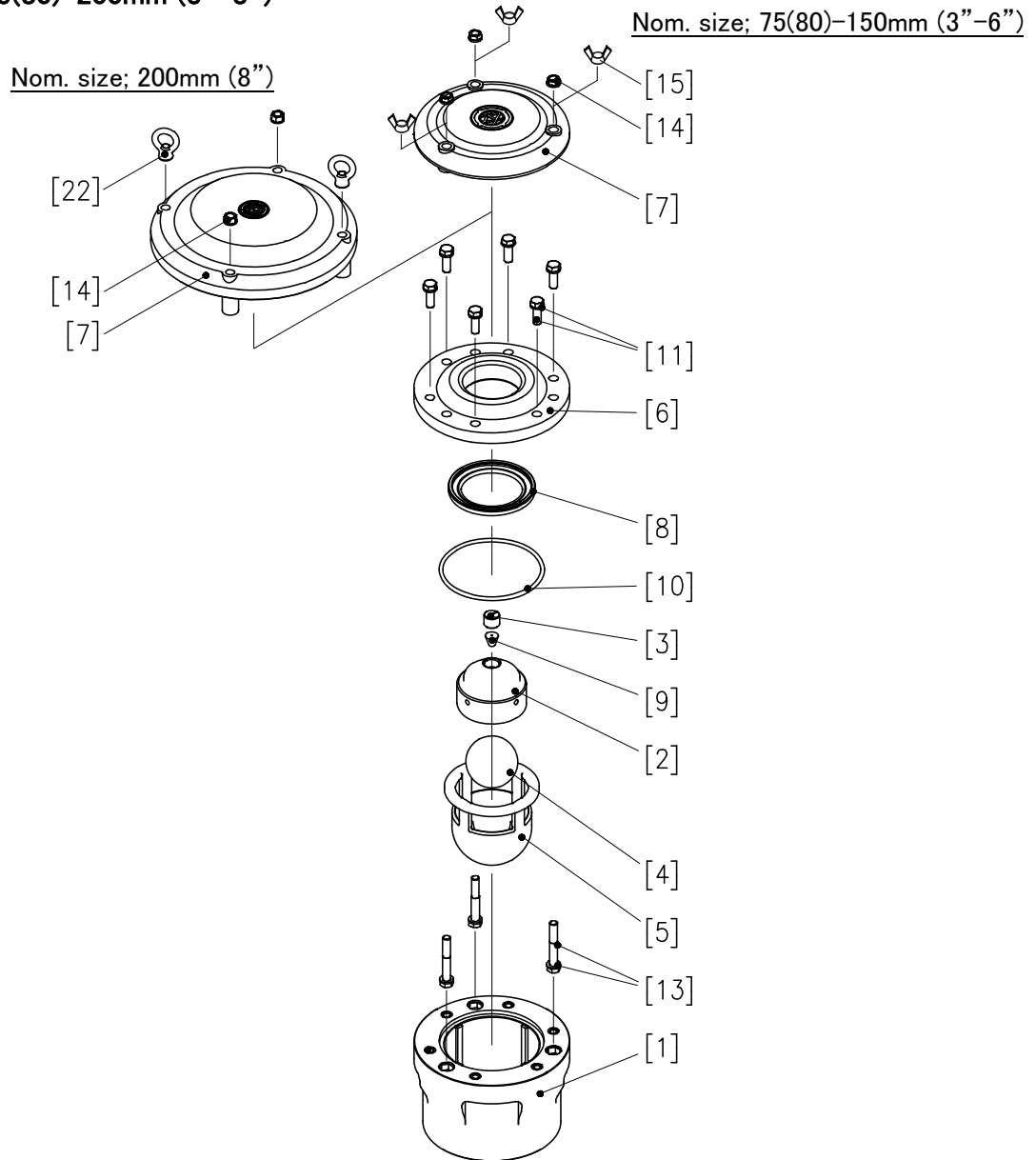

No.	Description	Remarks	No.	Description	Remarks
1	Body	AR : PDCPD AR for water : PDCPD + Epoxy resin coating	11	Bolt, washer (A)	100mm (4") M12, L=35
2	Disc	PP			150mm (6") M16, L=45
4	Float	PP			200mm (8") M16, L=45
5	Guide	75(80)-150mm (3"-6") : HI-PVC 200mm (8") : PDCPD	13	Bolt, washer (B)	75 (80)mm (3") M12, L=80
6	Bonnet	AR : PDCPD AR for water : PDCPD + Epoxy resin coating			100mm (4") M12, L=90
7	Cover	AR : PDCPD AR for water : PDCPD + Epoxy resin coating			150mm (6") M16, L=120
8	Seat (A)	AR : EPDM AR for water : SBR			200mm (8") M16, L=155
9	Seat (B)	AR : EPDM AR for water : SBR	14	Nut (B)	100mm (4") M12
10	O-ring	75 (80)mm (3") AR : EPDM (P150) AR for water : SBR (P150)			150mm (6") M16
		100mm (4") AR : EPDM (G175) AR for water : SBR (G175)			200mm (8") M16
		150mm (6") AR : EPDM (P250) AR for water : SBR (P250)			
		200mm (8") AR : EPDM (P335) AR for water : SBR (P335)			
11	Bolt, washer (A)	75 (80)mm (3") M12, L=35	15	Wing nut	75 (80)mm (3") M12
			22	Eye nut	200mm (8") only

6. Working pressure vs. temperature

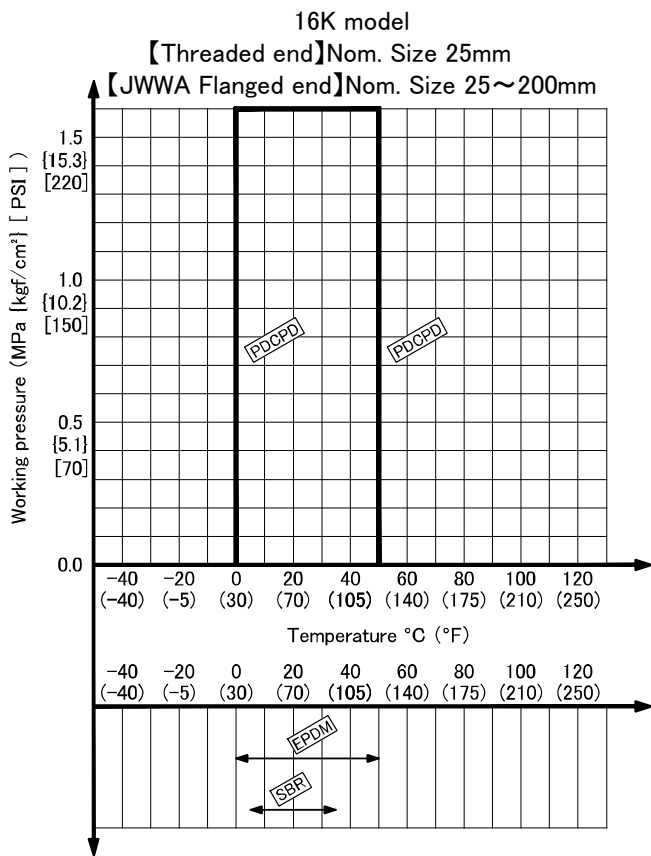
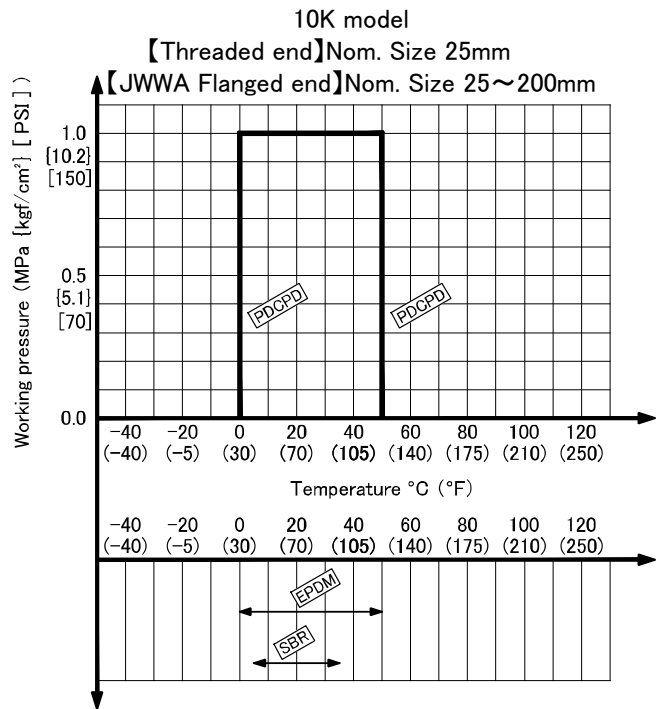
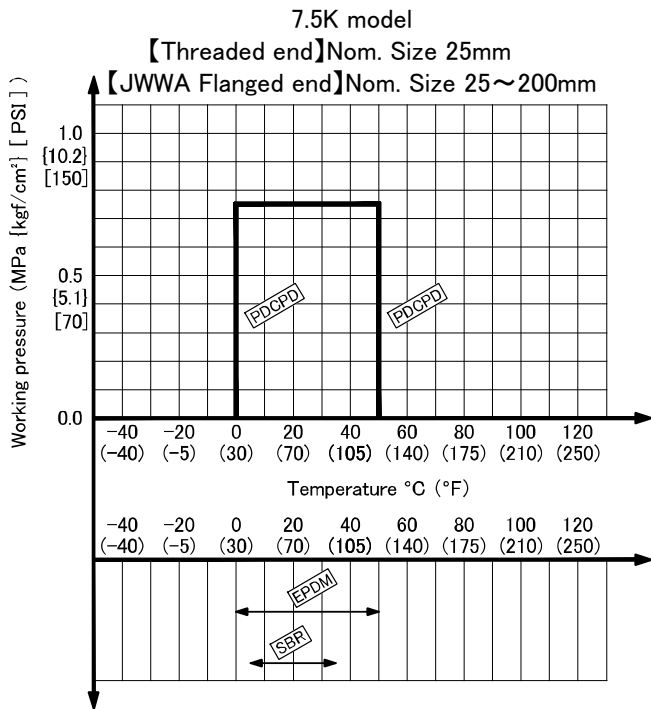

Nominal size	25-200mm (1"-8")
Minimum working pressure (kPa) [kgf/cm ²] [psi]	4.9 [0.050] [0.71]

7. Installation procedure

- Warning** (Warning icon) – When suspending and supporting a valve, take care and do not stand under a suspended valve.
- Caution** (Caution icon) – Be sure to conduct a safety check on all hand and power tools to be used before beginning work.
- Wear protective gloves and safety goggles as fluid remain in the valve even if the pipeline is empty. (You may be injured.)
 - Before a water test, be sure that the bolts and nuts is tightly fastened
- Caution** (Caution icon) – Use flat faced flanges for connection to AV Valves.
- Ensure that the mating flanges are of the same standards.
 - Be sure to use supplied sealing gaskets (AV Gasket etc.), bolts, nuts, and washers and tighten them to specified torques.
- (When a non-supplied sealing gasket is used, a different tightening torque instruction should be followed.)

Necessary items

- Bolt, Nut, Washer
- Supplied sealing gasket
- Torque wrench or adjustable head type torque wrench (Refer to right fig)



Procedure

Nominal size 25mm (1")

- 1) Set the sealing gasket between the valve and flanges.
- 2) Insert bolts, nuts, and washers, Then temporarily tighten by hand. (Refer to fig.-1 and table-1)
- 3) Tighten the bolts and nuts gradually with a torque wrench to the specified torque level in a diagonal manner. (Refer to fig.-2 and table-2)
- 4) Tighten it more than 2 turns clockwise with specified torque. (Refer to fig.-2 and table-2)

Nominal size 75(80)~200mm (3"-8")

- 1) Screw the stat bolt into the bottom side of the body.
- 2) Set the sealing gasket between the valve and flanges.
- 3) Insert nuts, and washers, then temporarily tighten by hand. (Refer to fig.-1 and table-1)
- 4) Tighten the bolts and nuts gradually with a torque wrench to the specified torque level in a diagonal manner. (Refer to fig.-2 and table-2)
- 5) Tighten it more than 2 turns clockwise with specified torque. (Refer to fig.-2 and table-2)

- Caution** (Caution icon) – The parallelism and axial misalignment of the flange surface should be under the values shown in the following table to prevent damage the valve. (A failure to observe them can cause destruction due to stress application to the pipe.)

Table-1 Axial misalignment and Parallelism

Nominal size	Axial misalignment	Parallelism (a-b)
25-150mm (1"-6")	1.0mm (0.04 inch)	1.0mm (0.04 inch)
200mm (8")	1.5mm (0.06 inch)	1.0mm (0.04 inch)

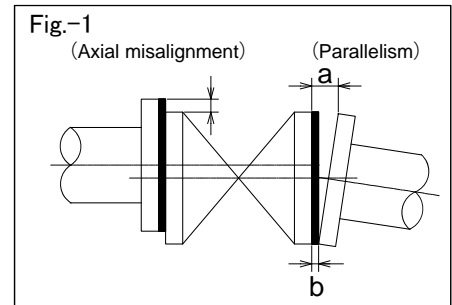

- Caution** (Caution icon) – Do not tighten above the specified torque value. (The valve can be damaged or leaks.)

Table-2 Specified torque value Unit : N·m [kgf·cm] [lb·in]

Nominal size	25-100mm (1"-4")		150mm (6")		200mm (8")	
	JWWA JIS10K	JIS16K	JWWA JIS10K	JIS16K	JWWA JIS10K	JIS16K
Torque value	30.0 {306} [266]	40.0 {408} [355]	40.0 {408} [355]	50.0 {510} [443]	55.0 {561} [488]	65.0 {663} [575]

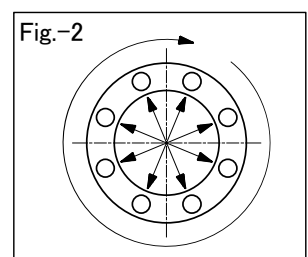

8. Operating procedure

– Attention to Isolating valves,



- 1) Do not exert excessive force in open/close the valve. (The hand wheel can be damaged.)
- 2) Do not open/close the valve when foreign matters such as dust are included in fluid.



- 3) Foreign matters such as sand may be left inside the pipeline after the installation of the valve. Therefore, clean inside the pipe before opening/closing the valve.
- 4) When operating the handle, be sure to do so with your hand. (Using a tool may damage the hand wheel.)

– Open and close the valve by turning handle softly. (Turn clockwise to close, and counter clockwise to open.)

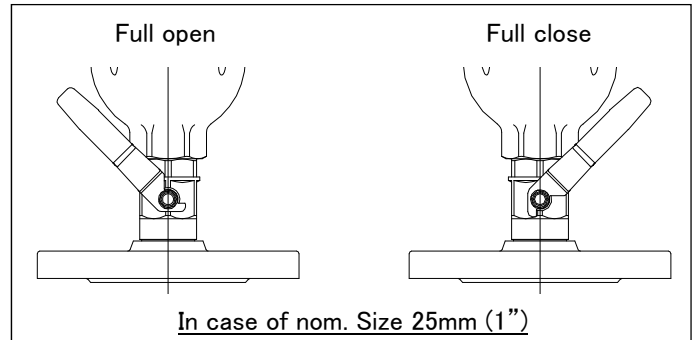

9. Disassembling method for replacing parts



- Be sure to conduct a safety check on all hand and power tools to be used before beginning work.
- Wear protective gloves and safety goggles as fluid remain in the valve even if the pipeline is empty. (You may be injured.)
- When replacing valves and parts, completely eliminate pressure in the pipe.

Necessary items

- Protective gloves
- Safety goggles
- Spanner wrench
- Silicone grease

< Disassembly > Procedure

Nominal size 25mm (1")

- 1) Close the isolating valve.
- 2) Loosen the wing nut, and remove the spring lock washer and washer.
- 3) Remove the cover.
- 4) Loosen the bolt (A), and remove the washer (A).
- 5) Remove the bonnet and take all the parts inside of body out.
- 6) Remove the seat (A) secured to the bonnet.
- 7) Remove the seat (B) secured to the disc.

Nominal size 75(80)–200mm (3”–8”)

- 1) Loosen the nut (B) or wing nut, and remove the washer.
- 2) Remove the cover.
- 3) Loosen the bolt, and remove the bolt and washer.
- 4) Remove the bonnet and take all the parts inside of body out.
- 5) Remove the seat (A) secured to the bonnet.
- 6) Remove the seat (B) secured to the disc.

< Assembly > Procedure

- 1) The procedure of the assembly is the reverse order of its disassembly.

- Before starting assembly, silicone grease should be spread on the O-rings, seat (A) and seat (B).
- Tighten the bolts (A) gradually with torque wrench to the specified torque in a diagonal manner.

Recommended torque value of bolt (A)			Unit : N-m {kgf-cm} [lb-in]		
Nominal size	25mm (1”)	75 (80)mm (3”)	100mm (4”)	150mm (6”)	200mm (8”)
Torque value	15.0 {153} [133]	15.0 {153} [133]	15.0 {153} [133]	30.0 {306} [266]	30.0 {306} [266]

10. Inspection items





– Perform periodic maintenance. (Leakage may develop due to temperature changes or over periods of prolonged storage, rest or operation.)

(1)	Existence of scratches, cracks, deformation, and discoloring.
(2)	Existence of leakage from the valve to the outside.
(3)	Tightening condition of bolt and nut. (Loose or not.)
(4)	Handle operation a smoothly or not.
(5)	Tighten up the bolt (A) etc. to the specified torque or not.

11. Troubleshooting

Problem	Cause	Treatment
Fluid leaks to the outside.	The seat (A) or (B) is damaged or worn.	Replace the disc set <Disc set> Disc, Bonnet, Seat (A), Seat (B), and O-ring
	The O ring is damaged or worn.	
Fluid is not stopped in the full closed position at the seat.	Lack of back pressure.	Check the back pressure. (Refer to page 7.)
	Foreign matter is in the valve.	Disassemble and cleaning.
	The seat (A) or (B) is damaged or worn.	Replace the disc set <Disc set> Disc, Bonnet, Seat (A), Seat (B), and O-ring
	The disc or float is damaged or worn.	
Fluid leaks from the air release valve even when the isolating valve is closed fully.	Foreign matter is attached.	Disassemble and cleaning.
	The isolating valve is broken.	Replace the isolating valve.
The handle of isolating valve does not work smoothly.	Foreign matter is attached.	Disassemble and cleaning.
Isolating valve does not operate.	The stem is broken.	Replace the isolating valve.

12. Handling of residual and waste materials

  – Make sure to consult a waste treatment dealer for recommendations on the proper disposal of plastic valves. (Poisonous gas is generated when the valve is burned improperly.)

Air Release Valve
Air Release Valve for water

ASAHI YUKIZAI CORPORATION



Distributor

<http://www.asahi-yukizai.co.jp/en/>

Serial No.	H-V059-E-5
------------	------------

Isolating Valve Isolating Valve for Water

User's manual





Contents (page)

- (1) Be sure to read the following warranty clauses of our product 1
- (2) General operating instructions 2
- (3) General instructions for transportation, unpacking and storage 2
- (4) List of ancillary parts 3
- (5) Name of parts 4
- (6) Working pressure vs. temperature 6
- (7) Installation procedure 7
- (8) Operating procedure 8
- (9) Inspection items 9
- (10) Troubleshooting 9
- (11) Handling of residual and waste materials 9



This user's guide contains very important information for the proper installation, maintenance and safe use of an ASAHI AV Product.

Please store this manual in an easily accessible location.

<Warning & Caution Signs>

 Warning	<p>This symbol reminds the user to take caution due to the potential for serious injury or death.</p>
 Caution	<p>This symbol reminds the user to take caution due to the potential for damage to the valve if used in such a manner.</p>







<Prohibited & Mandatory Action Signs>

	<p>Prohibited: When operating the valve, this symbol indicates an action that should not be taken.</p>
	<p>Mandatory action: When operating the valve, this symbol indicates mandatory actions that must be adhered to.</p>





1. Be sure to read the following warranty clauses of our product

- Always observe the specifications of and the precautions and instructions on using our product.
 - We always strive to improve product quality and reliability, but cannot guarantee perfection. Therefore, should you intend to use this product with any equipment or machinery that may pose the risk of serious or even fatal injury, or property damage, ensure an appropriate safety design or take other measures with sufficient consideration given to possible problems. We shall assume no responsibility for any inconvenience stemming from any action on your part without our written consent in the form of specifications or other documented approval.
 - The related technical documents, operation manuals, and other documentation prescribe precautions on selecting, constructing, installing, operating, maintaining, and servicing our products. For details, consult with our nearest distributor or agent.
 - Our product warranty extends for one and a half years after the product is shipped from our factory or one year after the product is installed, whichever comes first. Any product abnormality that occurs during the warranty period or which is reported to us will be investigated immediately to identify its cause. Should our product be deemed defective, we shall assume the responsibility to repair or replace it free of charge.
 - Any repair or replacement needed after the warranty period ends shall be charged to the customer.
 - The warranty does not cover the following cases:
 - (1) Using our product under any condition not covered by our defined scope of warranty.
 - (2) Failure to observe our defined precautions or instructions regarding the construction, installation, handling, maintenance, or servicing of our product.
 - (3) Any inconvenience caused by any product other than ours.
 - (4) Remodeling or otherwise modifying our product by anyone other than us.
 - (5) Using any part of our product for anything other than the intended use of the product.
 - (6) Any abnormality that occurs due to a natural disaster, accident, or other incident not stemming from something inside our product.
- * Note that damage induced by a defect of our product is not covered by warranty.

2. General operating instructions

-   – Do not disassemble the Isolating Valve. (If repair is necessary, please consult with our nearest distributor or service station.)
-   – Do not step on or apply excessive weight on valve. (It can be damaged.)
-  – Keep the valve away from excessive heat or fire. (It can be damaged, or destroyed.)
-  – Always operate the valve within the pressure vs. temperature range. (The valve can be damaged or deformed by operating beyond the allowable range.)
- Allow sufficient space for maintenance and inspection.
- Do not use the valve in conditions where the fluid may have crystallized. (The valve will not operate properly.)
- Keep the valve out of direct sunlight, water and dust. Use cover to shield the valve. (The valve will not operate properly.)
- Perform periodic maintenance. (Leakage may develop due to temperature changes or over periods of prolonged storage, rest or operation.)
- If any part has the risk of freezing, insulate it thermally.
- Immediately after installing the pipeline, or in similar cases, the pipe may contain accumulated soil, sand, dirt, or dust. If, therefore, the valve is subjected to water (filled with water) for the first time, discharge such soil, sand, dirt, and dust sufficiently by using a mud discharge valve or something similar.

3. General instructions for transportation, unpacking and storage

-   – When suspending and supporting a valve, take care and do not stand under a suspended valve.
-   – This valve is not designed to handle impacts of any kind. Avoid throwing or dropping the valve.
- Avoid scratching the valve with any sharp object.
- Do not over-stack cardboard shipping boxes. Excessively stacked packages may collapse.
- Avoid contact with any coal tar creosote, insecticides, vermicides or paint. (These chemicals may cause damage to the valve.)
- When transporting a valve, do not carry it by the handle.
-  – Store products in their corrugated cardboard boxes. Avoid exposing products to direct sunlight, and store them indoors (at room temperature). Also avoid storing products in areas with excessive temperatures. (Corrugated cardboard packages become weaker as they become wet with water or other liquid. Take care in storage and handling.)
- After unpacking the products, check that they are defect-free and meet the specifications.

4. List of ancillary parts

Nominal size	End connectors	Ancillary parts	Remarks	Pcs.
75mm (3")	JWWA	AV Gasket	SBR / JWWA 75mm (3") *1)	1
80mm (3")	JIS10K	AV Gasket	Isolating Valve : EPDM / JIS10K 80mm (3") *1) Isolating Valve for water : SBR / JIS10K 80mm (3") *1)	1
		JIS16K	Gasket with rib	Isolating Valve : EPDM / JIS16K 80mm (3") *1) Isolating Valve for water : SBR / JIS16K 80mm (3") *1)
	Dedicated nut *3)		M20	
100mm (4")	JWWA	AV Gasket	SBR / JWWA 100mm (4") *2)	1
	JIS10K	AV Gasket	Isolating Valve : EPDM / JIS10K 100mm (4") *2) Isolating Valve for water : SBR / JIS10K 100mm (4") *2)	1
		JIS16K	Gasket with rib	Isolating Valve : EPDM / JIS16K 100mm (4") *2) Isolating Valve for water : SBR / JIS16K 100mm (4") *2)
150mm (6")	JWWA	AV Gasket	SBR / JWWA 150mm (6")	1
		Stud bolt / Nut / Washer	M16*80L / M16 / Nom. 16	6
	JIS10K	AV Gasket	Isolating Valve : EPDM / JIS10K 150mm (6") Isolating Valve for water : SBR / JIS10K 150mm (6")	1
		Stud bolt / Nut / Washer	M20*90L / M20 / Nom. 20	8
	JIS16K	Gasket with rib	Isolating Valve : EPDM / JIS16K 150mm (6") Isolating Valve for water : SBR / JIS16K 150mm (6")	1
		Stud bolt / Nut / Washer	M22*90L / M22 / Nom. 22	12
200mm (8")	JWWA	AV Gasket	SBR / JWWA 200mm (8")	1
		Stud bolt / Nut / Washer	M16*80L / M16 / Nom. 16	8
	JIS10K	AV Gasket	Isolating Valve : EPDM / JIS10K 200mm (8") Isolating Valve for water : SBR / JIS10K 200mm (8")	1
		Stud bolt / Nut / Washer	M20*90L / M20 / Nom. 20	12
	JIS16K	Gasket with rib	Isolating Valve : EPDM / JIS16K 200mm (8") Isolating Valve for water : SBR / JIS16K 200mm (8")	1
		Stud bolt / Nut / Washer	M22*90L / M22 / Nom. 22	12

*1): The Bolts, Nuts and Washers are not packed with a product. Please prepare them by yourself. M16 bolt, nut & washer are recommended for 75(80) mm (3"). Flange Thickness of the valve shall be 22mm.

*2): The Bolts, Nuts and Washers are not packed with a product. Please prepare them by yourself. M16 bolt, nut & washer are recommended for 100mm (4"). Flange Thickness of the valve shall be 24mm.

*3): The nut of JIS 16K specification with a nominal size of 80 mm is a dedicated nut for connecting around the stem of the ASAHI AV Isolating valve JIS 16 K specifications.

5. Names of parts

75(80)mm (3")

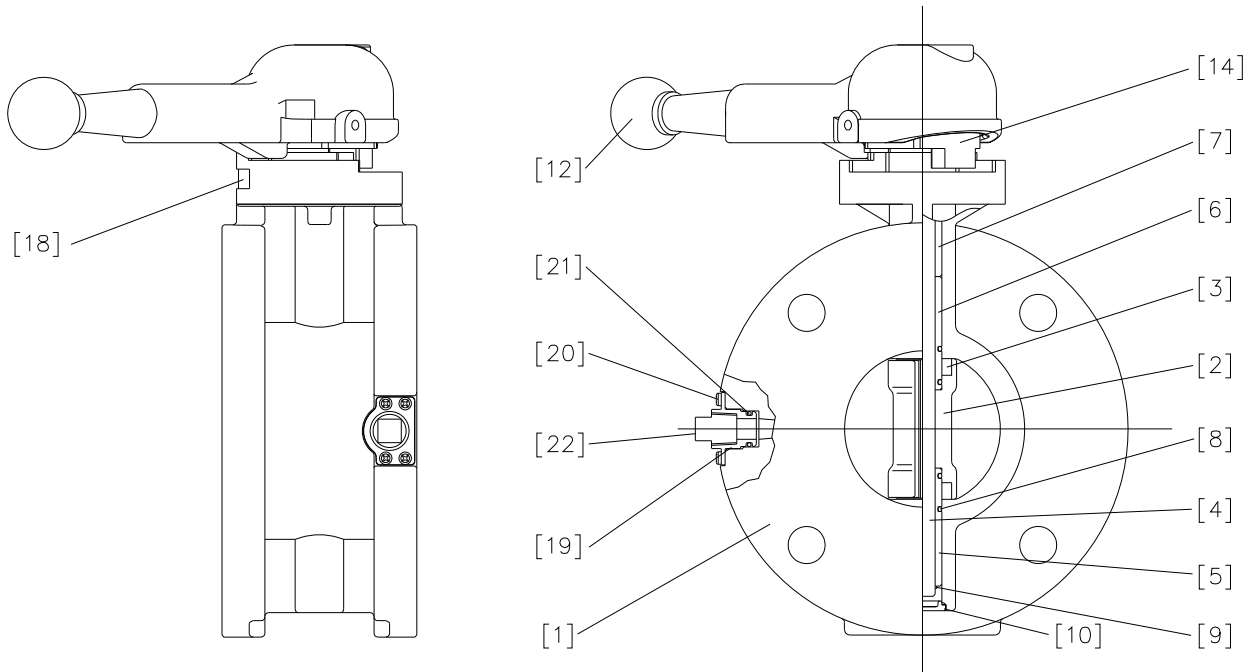

No.	Description	Remarks	No.	Description	Remarks
1	Body	HI-PVC	10	Cap	EPDM
2	Gate	HI-PVC	11	Thrust ring	PP
3	Seat	IV *1) : EPDM	12	Handle	ABS
		IV for water *1) : SBR	14	Adapter	ABS
4	Stem	Carbon steel (S45C)	18	Indicator Label	PVC
5	Bushing (A)	PP	19	Metal fitting	Copper alloy (C3604)
6	Bushing (B)	PP	20	Tapping Screw	Stainless steel (SUS304)
7	Bushing (C)	PP	21	O-ring	IV *1) : EPDM
8	O-ring	IV *1) : EPDM IV for water *1) : SBR			IV for water *1) : SBR
9	Retaining Ring C-type	Stainless steel (SUS304)	22	Plug cap	Stainless steel (SUS304)

*1: "IV" means "Isolating Valve". "IV for Water" means "Isolating Valve for Water".

100-200mm (4"-8")

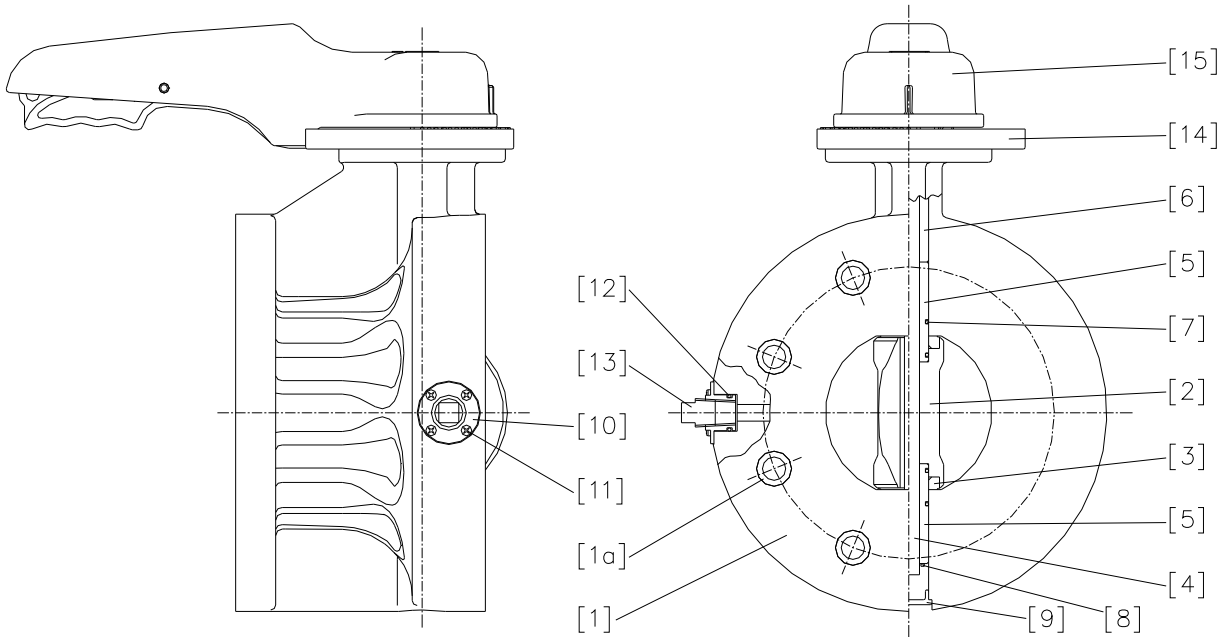

* The shape and appearance of assembly differ a little with the standard of connection compared to this drawing.



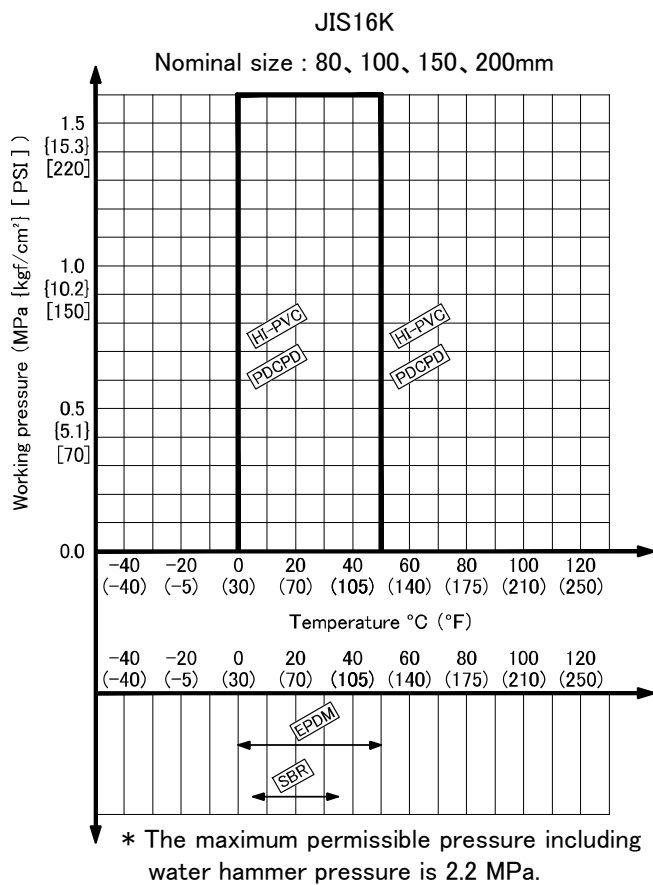
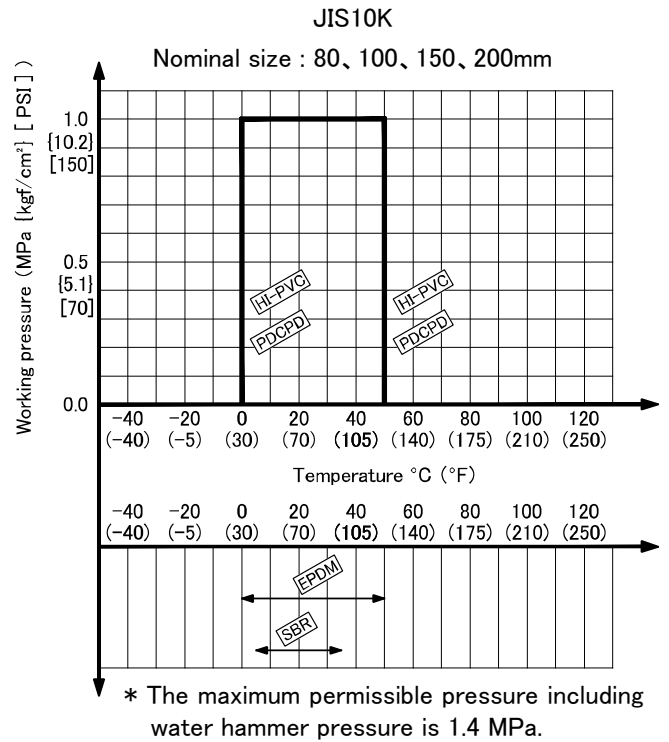
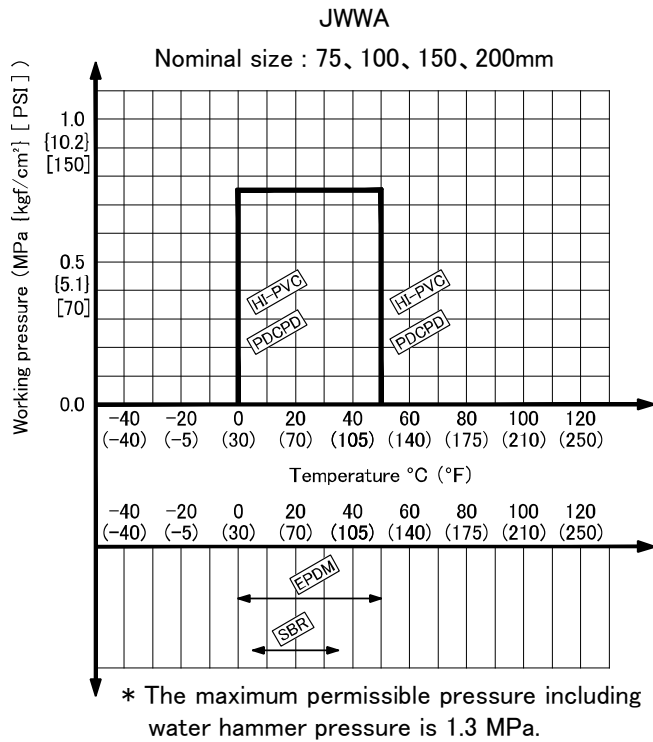

No.	Description	Remarks	No.	Description	Remarks
1	Body	100mm (4") : HI-PVC	8	Retaining Ring C-type	Stainless steel (SUS304)
		150, 200mm (6", 8") : IV : PDCPD IV for water : PDCPD + Epoxy resin coating			
1a	Inserted metal	Copper alloy (C3604) Used for 150, 200mm (6", 8")	9	Cap	EPDM
2	Gate	HI-PVC	10	Metal fitting	Copper alloy (C3604)
3	Seat	IV *1) : EPDM IV for water *1) : SBR	11	Tapping Screw	Stainless steel (SUS304)
4	Stem	Stainless steel (SUS403)	12	O-ring (A)	IV *1) : EPDM IV for water *1) : SBR
5	Bushing (A)	PP	13	Plug cap	Stainless steel (SUS304)
6	Bushing (B)	PP	14	Locking plate	PPG
7	O-ring	IV *1) : EPDM IV for water *1) : SBR	15	Lever	PP, PPG etc.

*1: "IV" means "Isolating Valve". "IV for Water" means "Isolating Valve for Water".

6. Working pressure vs. temperature



7. Installation procedure

-   - When suspending and supporting a valve, take care and do not stand under a suspended valve.
 -  - Be sure to conduct a safety check on all hand and power tools to be used before beginning work.
 - Wear protective gloves and safety goggles as fluid remain in the valve even if the pipeline is empty. (You may be injured.)
 - Before a water test, be sure that the bolts and nuts is tightly fastened.
 - Do not bring your face close to the plug cap.
 -   - Use flat faced flanges for connection to AV Valves.
 - Ensure that the mating flanges are of the same standards.
 - Be sure to use supplied sealing gaskets (AV Gasket etc.), bolts, nuts, and washers and tighten them to specified torques.
- (When a non-supplied sealing gasket is used, a different tightening torque instruction should be followed.)

Necessary items

- Bolt, Nut, Washer
- Supplied sealing gasket
- Torque wrench or adjustable head type torque wrench (Refer to right fig)



Installation of valve

Procedure

- 1) For the 150 and 200mm (6" and 8"), screw the bolt into the metal fitting. (Refer to right side fig.)
- 2) Set the sealing gasket between the valve and flanges.
- 3) Insert bolts, nuts, and washers to the 75, 80, and 100mm (3" and 4"), then temporarily tighten by hand. Insert nuts and washers to the 150 and 200mm (6" and 8"), then temporarily tighten by hand. (Refer to fig.-1 and table-1)
- 4) Tighten the bolts and nuts gradually with a torque wrench to the specified torque level in a diagonal manner. (Refer to fig.-2 and table-2)
- 5) Tighten it more than 2 turns clockwise with specified torque. (Refer to fig.-2 and table-2)

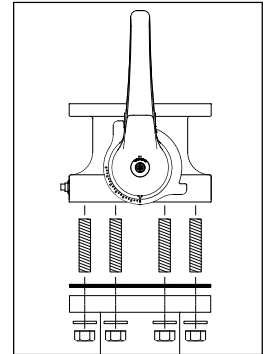



-   - The parallelism and axial misalignment of the flange surface should be under the values shown in the following table to prevent damage the valve. (A failure to observe them can cause destruction due to stress application to the pipe.)

Table-1 Axial misalignment and Parallelism

Nominal size	Axial misalignment	Parallelism (a-b)
75 (80)-150mm (3"-6")	1.0mm (0.04 inch)	1.0mm (0.04 inch)
200mm (8")	1.5mm (0.06 inch)	1.0mm (0.04 inch)





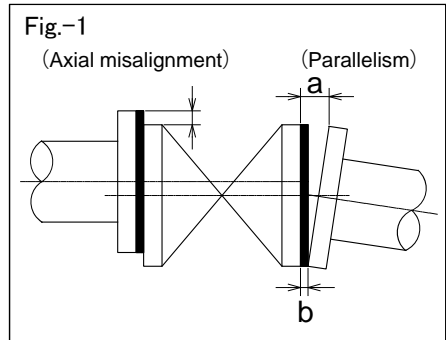

-   - Do not tighten above the specified torque value. (The valve can be damaged or leaks.)

Table-2 Specified torque value Unit : N-m [kgf-cm] [lb-in]

Nominal size	75 (80), 100mm (3", 4")		150mm (6")		200mm (8")	
	JWWA JIS10K	JIS16K	JWWA JIS10K	JIS16K	JWWA JIS10K	JIS16K
Torque value	30.0 {306} [266]	40.0 {408} [355]	40.0 {408} [355]	50.0 {510} [443]	55.0 {561} [488]	65.0 {663} [575]

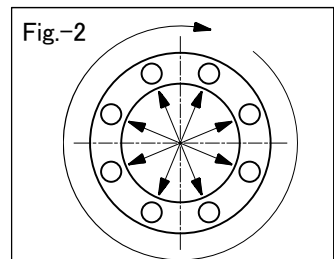

Installation of pressure gauge etc.

 - Do not bring your face close to the plug cap.

There is a screw (Rc3/8) on the side of the body.
Used when installing pressure gauge etc.

Procedure

- 1) Make sure that no hydraulic pressure left in the isolating valve.
- 2) Remove the plug from body.
- 3) Remove the sealing tape remaining in the screw hole completely.
- 4) Wrap the seal tape around the threaded area of instrument and screw that to the body.

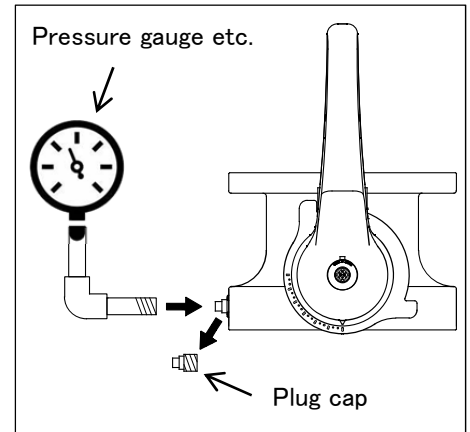

 - Do not screw the pressure gauge etc. more than necessary. (The valve body can be damaged.)

8. Operating procedure

 - Do not exert excessive force in open/close the valve. (The handle can be damaged.)

-  - Foreign matters such as sand may be left inside the pipeline after the installation of the valve. Therefore, clean inside the pipe before opening/closing the valve.
- When operating the handle, be sure to do so with your hand. (Using a tool may damage the hand wheel.)

Procedure

- 1) Lift the lever until the lock is free.
(Refer to right side fig.)
- 2) Rotate the handle smoothly to open or close position.

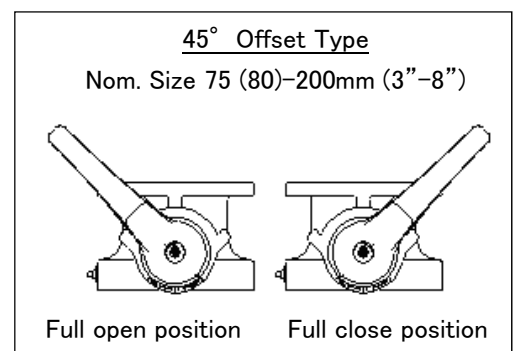
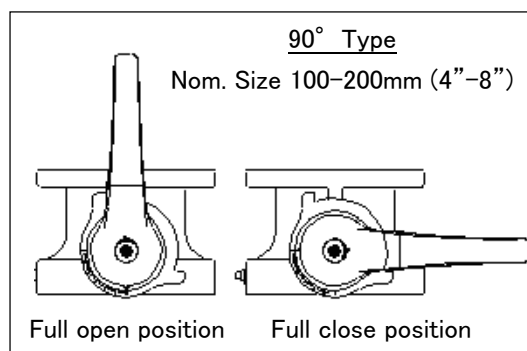
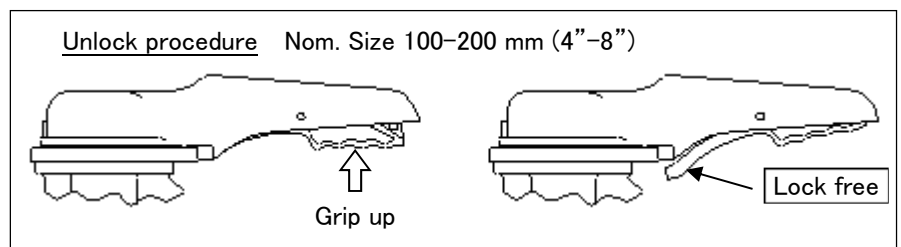
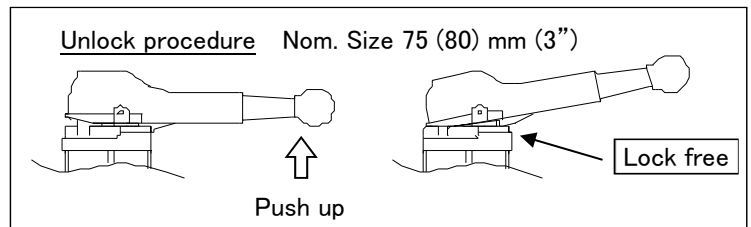

* Actual valve may differ slightly from the pictures shown.

9. Inspection items



– Perform periodic maintenance. (Leakage may develop due to temperature changes or over periods of prolonged storage, rest or operation.)

(1)	Existence of scratches, cracks, deformation, and discoloring.
(2)	Existence of leakage from the valve to the outside.
(3)	Tightening condition of respective threaded portions. (Loose or not)
(4)	Hand wheel operation smoothly or not.
(5)	Tighten up the bolt to the specified torque or not.

10. Troubleshooting

Problem	Cause	Treatment
Fluid leaks from the valve even when the valve is closed fully.	The seat is scratched or worn.	Please consult with our nearest distributor or service station.
	The gate is scratched or worn.	
	Solid particles have lodged.	Disassemble and cleaning.
Fluid leaks from the valve.	The O-ring is scratched or worn.	Please consult with our nearest distributor or service station.
	The plug cap is loosened.	Tighten up the plug cap.
	The connecting bolts are over tightened or tightened unevenly.	Adjust and retighten.
The handle of valve does not work smoothly.	Foreign matter is attached.	Disassemble and cleaning.
	Deformation. (By heat etc.)	Please consult with our nearest distributor or service station.
Valve does not operate.	The stem is broken.	Please consult with our nearest distributor or service station.
	The engagement between the stem and the gate is broken.	Please consult with our nearest distributor or service station.
	The engagement between the stem and the handle is broken.	Please consult with our nearest distributor or service station.

* If repair is necessary, please consult with our nearest distributor or service station.

* Do not replace the parts by the customer.

11. Handling of residual and waste materials



– Make sure to consult a waste treatment dealer for recommendations on the proper disposal of plastic valves. (Poisonous gas is generated when the valve is burned improperly.)

Isolating valve
Isolating valve for water

ASAHI YUKIZAI CORPORATION



Distributor

<http://www.asahi-yukizai.co.jp/en/>